

can-am®

CAN-AM ATVs



Accessories and Parts & Maintenance

2023



CAN-AM ATVs

ACCESSORIES

| | |
|-------------------------------|----|
| LinQ: Easy On, Easy Off Cargo | 6 |
| Racks & Holders | 11 |
| Cargo & Storage | 12 |
| Can-Am Windshields | 14 |
| Handlebars & Mirrors | 15 |
| Seats | 16 |
| Plastic Skid Plates | 17 |
| HMWPE Skid Plates | 18 |
| Aluminum Skid Plates | 19 |
| HMWPE & Aluminum Skid Plates | 21 |
| Bumpers & Guards | 22 |
| Lights & Electrical | 25 |
| Winches | 29 |
| Hitches | 31 |
| Performance | 32 |
| Covers, Decals & Add-Ons | 35 |
| Apache Track Systems | 37 |
| ProMount Plows | 40 |
| Tires & Rims | 45 |

PARTS AND MAINTENANCE

| | |
|----------------------------|----|
| Keep an Eye on These Parts | 50 |
| Genuine Parts | 51 |
| Lubricant & Oil Change Kit | 56 |
| Maintenance Products | 57 |
| Care Products | 58 |

CAN-AMOFFROAD.COM

© 2022 Bombardier Recreational Products Inc. (BRP). All rights reserved. ®, TM and the BRP logo are trademarks of BRP or its affiliates. All other trademarks are the property of their respective owners. BRP reserves the right to discontinue or change specifications, prices, designs, features, models or equipment without incurring obligation. Some models depicted may include optional equipment. Product performance may vary depending on weather, temperature, altitude, driving ability and driver/passenger weight. Prices, if shown, are based on the manufacturer's suggested retail price. Dealers may sell at a different price. BRP recommends that all ATV-SSV drivers take a training course. See your dealer or call the ATV Safety Institute at 1-800-887-2887 (USA) or the Canadian Safety Council at 1-613-739-1535 (Canada). ATVs and SSVs can be hazardous to operate. Never carry passengers on any ATV-SSV not specifically designed by the manufacturer for such use. All adult-model Can-Am ATVs are category G ATVs (general-use models) intended for recreational and/or utility use by an operator age 16 or older. Carefully read the vehicle's operator's guide. Follow all instructional and safety material and observe applicable laws and regulations. ATVs and SSVs are for off-road use only; never ride on paved surfaces or public roads. For your safety, the operator and passenger(s) must wear a helmet, eye protection and applicable protective clothing. Always remember that riding, alcohol and drugs don't mix. Never engage in stunt driving. Avoid excessive speed and be particularly careful on difficult terrain. Always ride responsibly and safely. See your authorized BRP dealer for details and visit can-am.brp.com. Printed in Canada.

CUSTOMIZING MADE EASY

1

Select
the
model.

2

Select
the
package.

3

Customize color, engine,
and accessories (or accessory
bundles) for your vehicle.

4

Click "Save"
or "Send
to dealer".

If you can dream it, you can build it. And ride it. Creating a Can-Am vehicle tailor-made for our riders' needs has never been easier. Visit CanAmOffRoad.com and follow the step-by-step above.

**BUILD
YOURS NOW**



ACCESSORIES ATV

BRP 2-YEAR LIMITED WARRANTY*

For new Can-Am accessories, genuine parts, and co-branded products sold through BRP. Includes items installed by you or an authorized BRP dealer.

The limited warranty is subject to the exclusions, limitations of liabilities and all other terms and conditions of BRP's standard limited warranty. See the complete limited warranty applicable to your product, or contact your authorized Can-Am Off-Road dealer. Applicable only to BRP products purchased at authorized BRP dealers or distributors. This limited warranty may not apply to factory-installed parts and accessories. Always refer to the product-specific limited warranty. Some states and provinces do not allow for some disclaimers, limitations and exclusions and, as a result, you have other specific rights.

ATV ACCESSORY COMPATIBILITY GUIDE

We've made things super simple.

- Check your model year
- Choose engine and model
- Learn your **PLATFORM CODE**

This **PLATFORM CODE** will let you know at a glance if the accessory is compatible with your vehicle.

| Model year | Model | Engine configuration | Platform code |
|------------|-----------------|----------------------|---------------|
| 2015 | Outlander L | 450, 500 | G2L |
| | Outlander | 500, 650, 800, 1000 | G2 |
| | Outlander L MAX | 450, 500 | G2L |
| | Outlander MAX | 500, 650, 800, 1000 | G2 |
| | 6x6 | 650, 1000 | G2 |
| | Renegade | 500, 800, 1000 | G2S |
| 2016 | Outlander L | 450, 570 | G2L |
| | Outlander | 570, 650, 850, 1000 | G2 |
| | Outlander L MAX | 450, 570 | G2L |
| | Outlander MAX | 570, 650, 850, 1000 | G2 |
| | 6x6 | 650, 1000 | G2 |
| | Renegade | 570, 850, 1000 | G2S |
| 2017 | Outlander | 450, 570 | G2L |
| | Outlander | 650, 850, 1000 | G2 |
| 2018 | Outlander MAX | 450, 570 | G2L |
| | Outlander MAX | 650, 850, 1000 | G2 |
| | 6x6 | 650, 1000 | G2 |
| | Renegade | 570, 850, 1000 | G2S |
| 2019 | Outlander | 450, 570 | G2L |
| | Outlander | 650, 850, 1000R | G2 |
| 2020 | Outlander MAX | 450, 570 | G2L |
| | Outlander MAX | 650, 850, 1000R | G2 |
| 2021 | 6x6 | 450 | G2L |
| | 6x6 | 650, 1000 | G2 |
| 2022 | 6x6 | 650, 1000 | G2 |
| | Renegade | 570, 650, 850, 1000R | G2S |
| 2023 | 6x6 | 650, 1000 | G2 |
| | Renegade | 570, 650, 850, 1000R | G2S |



LINQ: EASY ON, EASY OFF CARGO

LINQ ACCESSORIES

Compatibility/requirements

| <ul style="list-style-type: none"> • No tools needed: Quickly install and remove accessories by hand. • Equip your Can-Am for specialized tasks in no time. • Sturdy mounting system that holds up to the roughest terrain. | OUTLANDER 450/570 | OUTLANDER | RENEGADE |
|---|---|---|--|
| LinQ Accessories with 16" Base <ul style="list-style-type: none"> • LinQ anchors mounted 16 inches apart, center-to-center. • Lower loading capacity than the LinQ with 36" base accessories. • Can be used on Can-Am ATV and SSV vehicles, Can-Am Spyder and Ryker vehicles, Sea-Doo watercraft and Ski-Doo snowmobiles. | | | |
| LinQ 4.2 Gal (16 L) Cooler 219400964 • Black / 295100698 • White | LinQ Adapter Plate 715007273 & LinQ Base Installation Kit 715008125 | LinQ Anchor Adapter Kit 715004960 | LinQ Luggage Rack 715001734 & LinQ Anchor Adapter Kit 715004960 OR LinQ Adapter Plate 715007274 & LinQ Base Installation Kit 715008125 |
| LinQ Tool Box 715008111 | | | |
| LinQ SR 5.5 Gal (21 L) Bag 860202449 | | | |
| LinQ 4.5 Gal (17 L) Sport Bag 860202447 | | | |
| LinQ Modular Box 715005494 • (10 L) 715007112 • (20 L) 715006830 • (30 L) | | | |
| LinQ Tool Kit 715006829 | | | |
| LinQ Roll-Top Bag 715008110 | | | |
| LinQ Accessories with 36" Base <ul style="list-style-type: none"> • Mount on LinQ racks often used by Can-Am ORV vehicles. • Higher loading capacity than the LinQ with 16" base accessories. • Usage is limited to Can-Am ORV vehicles. | | | |
| LinQ 12 Gal (45 L) Cargo Box 715003879 | LinQ Base 715002350 | No further requirements | LinQ Luggage Rack 715001734 |
| LinQ 23 Gal (86 L) Trunk Box 715008749 | No compatibility | | |
| LinQ 32 Gal (121 L) Trunk Box 715001747 (2-up) 715001749 (MAX) | No compatibility | | |
| LinQ 11.5 Gal (43 L) Audio Cargo Box 715003018 | LinQ Base 715002350 | | |
| LinQ 8 Gal (30 L) Cooler Box 715004778 • Black / 715004698 • Gray | No compatibility | | |
| LinQ Premium Storage Bag by OGIO 715002923 • Black | LinQ Base 715002350 | | |
| LinQ Heavy Duty Basket 715001215 | | | |
| LinQ Low Profile Basket 715004282 | | | |
| LinQ Holders | | | |
| LinQ 4" Rack 715001711 • Silver / 715001665 • Black | Not compatible <i>*Alternative 5" or 8" Rack Extensions (715001913 or 715001914) are available for G2L</i> | No further requirements | LinQ Luggage Rack 715001734 |
| LinQ 6" (15 cm) Rack Extension 715001712 • Silver / 715001671 • Black | LinQ Base 715002350 | | |
| LinQ Mounted Gear Grips 715005340 | LinQ Base 715002350 | | |
| LinQ Tool Holder 715007358 | LinQ Base 715002350 | | |
| LinQ Gun Boot Rack 715002112 715002113 | Not compatible <i>*Alternative Gun Boot Racks (715001918 or 715001919) are available for G2L</i> | No compatibility | No compatibility |

LinQ Accessories with 16" base

LinQ Modular Box

G2, G2L, G2S

715005494 · (10 L)

715007112 · (20 L)

715006830 · (30 L)



- Allows stacking of other modular boxes to always have the right gear accessible.
- Always have the right box size to fit everything.
- Can be installed on any LinQ base with a 16" width.
- See table for installation location and requirements.

Thermal Insert For LinQ Modular Box (10 L)

G2, G2L, G2S

219401110



- Insulated liner.
- Fits very well in the LinQ Modular Box (10 L).
- Can contain five 473 ml cans or six 355 ml cans.

LinQ Tool Kit

G2, G2L, G2S

715006829



- Includes:
 - Cutter pliers
 - Long-nose pliers
 - Locking plier
 - Ratchet wrench 3/8" drive
 - 6" ratchet extension
 - Integrated CVT belt storage location (belt not included)
 - Long-socket 19 mm 3/8" drive - 6pts
 - Socket 18 mm 3/8" drive
 - Long-socket 17 mm 3/8" drive - 6pts
 - Socket 15 mm 3/8" drive
 - Socket 13 mm 3/8" drive
 - Socket 10 mm 3/8" drive
 - Socket 8 mm 3/8" drive
 - Combined wrench 19 mm
 - Combined wrench 18 mm
 - Combined wrench 15 mm
 - Combined wrench 13 mm
 - Combined wrench 10 mm
 - Combined wrench 8 mm
 - Socket Torx T40 3/8" drive
 - Socket Torx T30 3/8" drive
 - Socket Torx T20 3/8" drive
 - Breaker bar 3/8" drive
- See table for installation location and requirements.

LinQ 4.2 Gal (16 L) Cooler

G2, G2L, G2S

■ 219400964 · Black
■ 295100698 · Gray



- All the benefits of LinQ—simple, fast and secure.
- Rotomolded construction for exceptional rigidity and durability.
- Premium-quality foam insulation for optimal ice retention.
- Uses LinQ mounting system (Patent US 8777531 and US 8875830).
- Easy one-second on/off tool-less system.
- See table for installation location and requirements.

LinQ Tool Box

G2, G2L, G2S

715008111



- High precision injected HDPE construction provides rigidity and durability.
- 5 gal (19 L) maximum capacity.
- Weather-resistant, sealed and lockable cover.
- Marineized for salt water purposes.
- See table for installation location and requirements.

LinQ Roll-Top Bag

G2, G2L, G2S

715008110



- Fully waterproof Roll-Top dry bag will securely store and confine your equipment.
- LinQ mounted using heavy-duty rigid plastic base.
- High capacity storage solution 10.6 gal (40 L).
- Bottom foam liner for additional equipment protection.
- Integrated handle for easy transportation on/off the vehicle.
- Marineized for salt water purposes.
- See table for installation location and requirements.

| | | |
|-----------------------------------|--------------|------------------|
| SR 5.5 Gal (21 L) LinQ Bag | G2, G2L, G2S | 860202449 |
|-----------------------------------|--------------|------------------|



- Semi-rigid expandable bag.
- 5.5 gal (21 L) capacity.
- See table for installation location and requirements.

| | | |
|--------------------------------------|--------------|------------------|
| LinQ 4.5 Gal (17 L) Sport Bag | G2, G2L, G2S | 860202447 |
|--------------------------------------|--------------|------------------|



- 4.5 gal (17 L) capacity.
- Rigid bottom, semi-rigid top.
- See table for installation location and requirements.

LinQ Accessories with 36" base

| | | |
|-------------------------------------|--|------------------|
| LinQ 12 Gal (45 L) Cargo Box | G2 (front only for 6x6 & MAX models 2013-2014), G2L, G2S | 715003879 |
|-------------------------------------|--|------------------|



- LinQ mounted for easy on, easy off installation.
- Holds cargo safely and securely while riding.
- See table for installation location and requirements.

| | | |
|-------------------------------------|----------------------------------|------------------|
| LinQ 23 Gal (86 L) Trunk Box | G2 (except 6x6 models), G2L, G2S | 715008749 |
|-------------------------------------|----------------------------------|------------------|



- LinQ mounted for easy on, easy off installation.
- Lockable and weather-resistant.
- Holds cargo safely and securely while riding.
- Comfort pads for passenger.
- See table for installation location and requirements.

| | | |
|--------------------------------------|--|--|
| LinQ 32 Gal (121 L) Trunk Box | G2 (except MAX models & 6x6), G2S European Version (EC compliant) | 715001747 715001748 · No rear tail light. |
|--------------------------------------|--|--|



- LinQ Retrofit Adapter Plate (715001334) is required for G1 models.
- Trunk Box Panels available in many colors to match your vehicle (sold separately).
- See table for installation location and requirements.

| | | |
|--|---|--|
| LinQ 32 Gal (121 L) Trunk Box for Outlander Max | G2 (MAX models only except 6x6 models) European Version (EC compliant) | 715001749 715001750 · No rear tail light. |
|--|---|--|



- Passenger comfort is ensured on active rides as well as longer recreational rides thanks to the ergonomically designed passenger padding comfort-fitted with a portion made of closed cell foam that won't absorb water.
- Very easy to embark even when driver is seated.
- Trunk Box Panels available in many colors to match your vehicle (sold separately).

| | | |
|---|-----------------------------|--|
| LinQ 32 Gal (121 L) Trunk Box Panels | G2 (except 6x6 models), G2S | |
|---|-----------------------------|--|



- Color panels to match the LinQ 32 gal (121 L) Trunk Box to your vehicle.

- | | |
|----------------------------------|-------------------------------------|
| ■ 715001391 · Black | ■ 715002985 · Manta Green |
| ■ 715001392 · Yellow | ■ 715002986 · Can-Am Red |
| ■ 715001395 · Viper Red | ■ 715006119 · Orange Crush |
| □ 715002481 · White | ■ 715006120 · Squadron Green |
| ■ 715002480 · Light Gray | ■ 715007074 · Tundra Green |
| ■ 715002984 · Octane Blue | |

LinQ 32 Gal (121 L) Trunk Box Panels
(Not illustrated)

EUROPEAN VERSION (EC compliant)

- Color panels to match the LinQ 32 gal (121 L) Trunk Box to your vehicle.
- No rear tail light.

- | | |
|--------------------------------|-----------------------------------|
| ■ 715001397 · Black | ■ 715006122 · Manta Green |
| ■ 715001398 · Yellow | ■ 715006121 · Can-Am Red |
| ■ 715006124 · Viper Red | ■ 715006123 · Orange Crush |
| □ 715002483 · White | |

LinQ 11.5 Gal (43 L) Audio Cargo Box

G2 (front only for 6x6 & MAX models 2013-2014), G2L, G2S

715003018



- Mounts on/off easily to hold/carry cargo safely and securely.
- The Bluetooth enabled receiver and 6.5" (16.5 cm) speakers are smartly concealed and integrated in the cover.
- Automatic shut-off function protects your battery by turning the system off after 10 minutes of inactivity.
- Backlit control panel perfect for night riding.
- Water-resistant speakers.
- Delivers the best sound quality on the market to sweeten your ride courtesy of a built-in full range high-efficiency amplifier.
- See table for installation location and requirements.

LinQ 8 Gal (30 L) Cooler Box

G2 (except 6x6 models), G2S

■ **715004778** · Black
■ **715004698** · Gray



- LinQ mounted for easy on, easy off installation.
- Rotomolded construction provides exceptional rigidity and durability.
- Premium-quality foam insulation for optimal ice retention.
- Integrated, fully-removable compartment protects food.
- Robust rubber latches keep the cover tightly closed.
- Weather-resistant.
- Convenient drain plug.
- See table for installation location and requirements.

LinQ Premium Storage Bag by OGIO

G2 (except 6x6 models), G2L, G2S

■ **715002923** · Black



- LinQ mounted for easy on, easy off installation.
- Holds cargo safely and securely while riding.
- See table for installation location and requirements.

LinQ Low Profile Basket

G2, G2L (front only for MAX & 6x6 models), G2S

715004282



- Low profile, open basket increases cargo space.
- Perfect for easy access to tools, rope, winch and plow accessories.
- Multiple bungee cord and tie-down anchor points.
- Made of impact-resistant injected polypropylene.
- See table for installation location and requirements.

LinQ Heavy-Duty Basket

G2, G2L (front only for MAX & 6x6 models), G2S

715001215



- Made of high-strength, low-alloy steel.
- LinQ mount for easy on, easy off installation.
- Can be placed on both front and back racks of vehicle.
- See table for installation location and requirements.

Large Cargo Box

G2, G2L (except 6x6)

715007001



- Rear bed to carry large items.
- Anchor points (D-ring), LinQ fixtures for tool holder, and marks to allow the installation of a 16" accessory.
- Also has a mat for the floor and slot to enable the installation of a divider and a slot for a divider to close the recess on the rear vertical lip.
- It is installed on ATV platforms through the LinQ system and hooks to make it easily installable and removable.

LinQ Holders

LinQ Tool Holder

G2, G2S, G2L

715007358



- Ultra-versatile tool holder.
- Convenient swivel-latch allows tools to be stored in any orientation.
- Sold in pairs.

LinQ Gear Grips

G2, G2S, G2L

715005340



- Durable and flexible grips provide a custom fit for a variety of items from 1" to 4" (2.5 cm to 10 cm) in diameter.
- Heavy-duty design for carrying bows, fishing poles, rakes, farm tools and more.
- Quick-release button opens grip quickly for easy access to gear.
- Heavy-duty base system built for the toughest adventures.
- Make transporting your tools a snap by combining the Gear Grips with the LinQ System.
- 360° orientation.
- Sold in pairs.

LinQ Mounting

LinQ Anchor Adapter Kit

G2, G2S

715004960



- Allows the installation of accessories with LinQ base of 16" on LinQ racks.
- Tool-less installation and removal.
- For G2S, the LinQ Luggage Rack (715001734) is required for installation.

LinQ Base

G2L

715002350



- Made of polypropylene glass fiber.
- Allows you to install LinQ accessories.
- Sold in pack of 4.

LinQ Lock

G2, G2S, G2L,

860201968



- Simple way to securely lock most LinQ accessories.
- Lock cover protects lock from the elements.
- Corrosion resistant.
- Pack of 1, includes 2 keys.
- Not compatible with LinQ 4.2 US gal (16 L) Cooler, LinQ Tool Box, LinQ Tool Holder and LinQ Gear Grips.





LinQ Replacement Parts

715001707

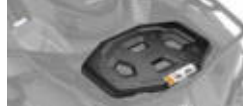

- Unique mounting fastener usable on any LinQ System accessory.
- Tool-less installation and removal.
- Sold in pairs.

RACKS & HOLDERS

| | | |
|---|--|---|
| LinQ Rack Extension – 4" (10 cm) | G2, G2S | ■ 715001711 · Silver ■ 715001665 · Black |
|  | <ul style="list-style-type: none"> • Fits front or rear. • Strong and durable. • Helps keep cargo securely in place. • Easy and tool-less installation thanks to the LinQ System. • Anti-corrosion coating with durable powder coat finish. • LinQ Luggage Rack (715001734) is required for G2S. | |
| LinQ Rack Extension – 6" (15 cm) | G2, G2S | ■ 715001712 · Silver ■ 715001671 · Black |
|  | <ul style="list-style-type: none"> • Fits front or rear. • Strong and durable. • Helps keep cargo securely in place. • Easy and tool-less installation thanks to the LinQ System. • Anti-corrosion coating with durable powder coat finish. • LinQ Luggage Rack (715001734) is required for G2S. | |
| Rack Extension – 5" (13 cm) | G2L | 715001913 |
|  | <ul style="list-style-type: none"> • Fits front or rear. • Made of carbon steel. • Provides tie-down points to secure cargo on racks. • Easy installation on tubular rack. • Anti-corrosion coating with durable powder coat finish. | |
| Rack Extension – 8" (20 cm) | G2L | 715001914 |
|  | <ul style="list-style-type: none"> • Fits front or rear. • Made of carbon steel. • Provides tie-down points to secure cargo on racks. • Easy installation on tubular rack. • Anti-corrosion coating with durable powder coat finish. | |
| LinQ Luggage Rack | G2S (except X mr models) | 715001734 |
|  | <ul style="list-style-type: none"> • Bolt-on rack. • Enables use of LinQ mounted accessories on the G2S. | |
| LinQ Base Plate | G2L | 715007273 |
|  | <ul style="list-style-type: none"> • Enables use of 16" wide LinQ base accessories on G2L to extend cargo options and journey opportunities. • Requires LinQ base kit (715008125). | |
| LinQ Base Plate | G2S | 715007274 |
|  | <ul style="list-style-type: none"> • Enables use of 16" wide LinQ base accessories on G2S to extend cargo options and journey opportunities. • Requires LinQ Base Kit (715008125). | |

| | | |
|----------------------|-------------------------|------------------|
| Gun Boot Rack | G2L (except MAX models) | 715001918 |
| | G2L (MAX models only) | 715001919 |



- Made of steel.
- Designed for the tubular rack.
- For use with Gun Boot 6.0 Impact by Kolpin.
- Can be mounted to either side of the vehicle.

| | | |
|--|---------|------------------|
| Gun Boot 6.0 Impact[†] By Kolpin[†] | G2, G2L | 715001419 |
|--|---------|------------------|



- Extra room for pistol-grip-type weapons and small bipods.
- Easily fits firearms up to 51" (130 cm) in total length.
- Provides ample room for 2 3/8" (60 mm) scopes.
- Hatchback design allows easy access.
- Ergonomically designed handle and molded attachment points for sling.
- Snap-close cover with locking capability.
- Designed to accommodate left and right hand bolt-action rifles and shotguns.
- Includes removable, shock absorbing foam and nylon Impact liner for superior interior protection.
- Requires appropriate mounting kit for installation.

| | | |
|---|----------------------------------|------------------|
| LinQ Gun Boot Rack <i>(Not illustrated)</i> | G2 (except MAX, 6x6 & X mr 1000) | 715002112 |
| | G2 (MAX & X mr 1000 models only) | 715002113 |

- This lightweight Gun Boot Rack can be mounted on either side of your Outlander using the tool-less LinQ System.
- For use with Gun Boot 6.0 Impact by Kolpin.

| | | |
|-------------------------|---------|---------------------------|
| Multi-Fit Holder | G2, G2L | 715002354 · Single |
| | | 715001945 · Double |



- Open U-shaped bracket for carrying tools (shovel, axe) and hunting weapons (rifle, bow) that are safely secured, but easily accessible.
- Easy installation on tubular rack, extension racks, basket or bumpers.
- For G2, the LinQ Rack Extension (715001711) is required.
- Sold in pairs.

| | | |
|------------------------|-----|------------------|
| LinQ Gear Grips | G2L | 715001421 |
|------------------------|-----|------------------|



- Durable, flexible grips cushion and protect while providing a custom fit for a variety of items from 1" to 4" (2.5 cm to 10 cm) in diameter.
- Heavy-duty design for carrying bows, fishing poles, rakes, farm tools and more.
- Quick-release button opens grip quickly for easy access to gear.
- Heavy-duty base system built for the toughest adventures.
- Easy installation on tubular racks, extension racks, brackets or bumpers.
- Sold in pairs.

CARGO & STORAGE

| | | |
|-----------------|----------------------|------------------|
| Log Bars | G2 (6x6 models only) | 715001987 |
|-----------------|----------------------|------------------|



- Log bars allow you to convert the cargo bed into a perfect transport space for 4' (120 cm) timber.
- The driver's safety is guaranteed by the protective front screen.

| | | |
|-----------------|----------------------|------------------|
| Hard Top | G2 (6x6 models only) | 715002394 |
|-----------------|----------------------|------------------|



- The hard top provides a 116 gal (440 L) cargo box.
- Locking secures your belongings.
- The cover raises assisted by gas cylinders.

| | | |
|----------------------------------|----------------------|------------------|
| Side Walls & Tailgate | G2 (6x6 models only) | 715005153 |
|----------------------------------|----------------------|------------------|



- Allows for a quick and easy conversion of the cargo bed into a trunk with plenty of room.
- Rotationally molded walls provide extreme durability for hard work - in all conditions.

Cargo Box Pool

G2L (6x6 models only)

715005256

- Transforms the flatbed into a large capacity cargo box for increased loading possibilities.
- Made of durable formed HDPE and shaped to maximize cargo space.
- Allows access to vehicle's water-resistant rear compartment.
- Designed for perfect fit and easy installation.

Tailgate Extension/Divider

G2 (6x6 models only)

715002017

- The sturdy tailgate extension provides a 10" (25 cm) extension to the cargo space.
- Thanks to the longer cargo bed, even large loads pose no problem.
- With the help of LinQ quick locks, the extension also acts as a solid space divider for the cargo bed.

Tarpaulin

G2 (6x6 models only)

715002416

- Fitted to cover all of the items in your cargo box thoroughly.
- Prevents splash from entering cargo box.
- Easily removable for quick access.

18 Gal (70 L) Utility Box

G2 (6x6 models only)

715001999

- Wherever you go and whatever you do, this handy 18 gal (70 L) utility box is your mobile storage.
- The lid keeps your equipment safe from the elements in all conditions.
- Slides under the flatbed with handles for easy access.

Cargo Box Net

G2 (6x6 models only)

715001371

- Solid net designed to hook to the bottom of the cargo box for secure and compact confinement of your cargo.

Soft Storage Bag

G2, G2L, G2S

715003759

- 3 -section bag.
- Transport gear in a weatherproof bag.
- 11.8 gal (45 L) capacity soft cargo bag designed with vehicle's rack in mind to maximize potential storage.
- LinQ Luggage Rack (715001734) is required for G2S.

Storage 2.6 Gal (10 L) Bag**269502121**

- Roll-Top dry bag for fully protecting your cargo from the elements.
- Fits in rear compartment of your vehicle.

CAN-AM WINDSHIELDS

| | | | |
|-----------------------|-----------------------------|----------------------------------|-------------------------------------|
| Deluxe Fairing | G2 (except X mr & 6x6), G2L | ■ 715001232 · Black | ■ 715006125 · Squadron Green |
| | | ■ 715000935 · Yellow 2000 | |
| | | ■ 715002479 · Light Gray | |



- Innovative, richly featured wind protection.
- Quick tool-less removal once base brackets are mounted on handlebar.
- Two cup holders.
- Ready for GPS mounting kit.
- Optional mirrors and auxiliary lighting.
- Requires low, high or extra high windshield.
- Tapered Handlebar Adapter Kit is required for vehicles with 1 1/8" (28 mm) tapered aluminum handlebars.
- Does not fit T3 models.

| | | | |
|---|----------------|--|--|
| Camo Decals for Black Deluxe Fairing <i>(Not illustrated)</i> | Deluxe Fairing | ■ 715002976 · Mossy Oak Break-Up Country Camo | ■ 715001684 · Next G-1 Vista Camo |
| | | • Camo pattern perfectly matches your camo vehicle. | |

| | | |
|--|----------------|--|
| Tapered Handlebar Adapter Kit <i>(Not illustrated)</i> | Deluxe Fairing | 715002470 |
| | | • Required to install Deluxe Fairing on an Outlander X-TP and on any vehicle equipped with 1 1/8" (28 mm) tapered aluminum handlebars. |

| | | |
|------------------------------|----------------|--|
| Extra High Windshield | Deluxe Fairing | 715000936 |
| | | <ul style="list-style-type: none"> • 16" (41 cm) windshield provides the ultimate protection against the elements while touring. • For wind protection and winter applications. • Tool-less installation and replacement. |



| | | |
|------------------------|----------------|---|
| High Windshield | Deluxe Fairing | 715001211 |
| | | <ul style="list-style-type: none"> • 11" (28 cm) high, for wind protection and winter applications. • Tool-less installation and replacement. |



| | | |
|-----------------------|----------------|--|
| Low Windshield | Deluxe Fairing | 715001227 |
| | | <ul style="list-style-type: none"> • 6" (15 cm) windshield allows you to keep your vehicle looking sporty while giving you some protection from the elements and the possibility of enjoying directional lighting. • Tool-less installation and replacement. |



Accessories

| | | |
|--------------------------------------|----------------|--|
| Auxiliary Windshield Lighting | Deluxe Fairing | 715003115 |
| | | <ul style="list-style-type: none"> • 2 premium LED spots for Deluxe Fairing for both increased output and directional lighting. • 1,800 lumens. • 2 x 10W LED Cree light kit. • Long-range illumination up to 350' (107 m), drawing less than 1 amp per light. |



| | | |
|--------------------------|----------------|---|
| Deluxe Mirror Kit | Deluxe Fairing | 715002353 |
| | | <ul style="list-style-type: none"> • Improved mounting system. • Wide rear view. • Perfect fit with your Deluxe Fairing. |



Windshield Kits

Extra High Windshield Kit

G2, G2L, G2S (except X mr models)

715003023



- Made of polycarbonate with integrated vent to reduce air turbulence and rumble noise at high speeds for a quieter and smoother ride.
- Quick tool-less removal once base brackets are mounted on handlebar.
- Fits straight and tapered handlebars.
- Improved design for enhanced rigidity.
- Steering Cover (709400939) is required for XT and Mossy Oak models.
- 16" (41 cm) windshield.
- For ultimate wind protection and winter applications.

High Windshield Kit

G2, G2L, G2S (except X mr models)

715006382



- Made of polycarbonate with integrated vent to reduce air turbulence and rumble noise at high speeds for a quieter and smoother ride.
- Quick tool-less removal once base brackets are mounted on handlebar.
- Fits straight and tapered handlebars.
- Improved design for enhanced rigidity.
- Steering Cover (709400939) is required for XT and Mossy Oak models.
- 11" (28 cm) windshield.
- For wind protection and winter applications.

Low Windshield Kit

G2, G2L, G2S (except X mr models)

715003021



- Made of polycarbonate with integrated vent to reduce air turbulence and rumble noise at high speeds for a quieter and smoother ride.
- Quick tool-less removal once base brackets are mounted on handlebar.
- Fits straight and tapered handlebars.
- Improved design for enhanced rigidity.
- Steering Cover (709400939) is required for XT and Mossy Oak models.
- 6" (15 cm) windshield.
- Allows you to keep your vehicle looking sporty while giving you some protection from the elements.

HANDLEBARS & MIRRORS

Handlebar Wind Deflectors

G2, G2L, G2S



- Rugged injected plastic construction with Can-Am logo.
- Include removable cap for air flow adjustment.
- Mounting kit sold separately.

- | | |
|---|---|
|  715000525 · Black / Yellow |  715003813 · Orange / Black |
|  715000537 · White / Black |  715003814 · Octane Blue / Black |
|  715001706 · Black / Black |  715006117 · Squadron Green / Black |
|  715003811 · Can-Am Red / Black |  715006118 · Viper Red / Black |
|  715003812 · Manta Green/Black | |

Passenger Wind Deflectors

G2 and G2L (MAX models only)

715001669



- These wind deflectors fit on the passenger handles and provide greater comfort while riding.
- Easy to install and remove.

Full Wrap Aluminum Mounting Kit

G2, G2L, G2S

715001378



- Lightweight black die cast aluminum construction.
- Includes complete hardware.
- Handlebar wind deflectors sold separately.

Aluminum Tapered Handlebar

G2, G2L, G2S

715000550



- 7/8" - 1 1/8" (22 mm - 28 mm) tapered handlebar made of 6061-T6 aluminum.
- Includes all hardware, center steering foam and cover.

| | | |
|-----------------------------------|---------|------------------|
| Xt Handlebar Protector Kit | G2, G2L | 703100352 |
|-----------------------------------|---------|------------------|



- Not compatible with Mud Strap (715003053).

| | | |
|------------------------------------|--------------|------------------|
| Mirrors Left – 3/8" (10 mm) | G2, G2L, G2S | 708200963 |
|------------------------------------|--------------|------------------|



- True vision surface 5" x 3" (13 cm x 8 cm).
- Matte finish.
- Stem includes 3/8" (10 mm) thread.
- Bracket (715000190) is required for installation on DS 450.
- Bracket not required for installation on Outlander and Renegade.

| | | |
|---|--------------|------------------|
| Mirrors Right – 3/8" (10 mm) <i>(Not illustrated)</i> | G2, G2L, G2S | 709400523 |
|---|--------------|------------------|

- True vision surface 5" x 3" (13 cm x 8 cm).
- Matte finish.
- Stem includes 3/8" (10 mm) thread.
- Bracket (715000190) required except for vehicles with right hand brake.

| | | |
|--------------------------|--------------|------------------|
| Handlebar Mirrors | G2, G2L, G2S | 715005366 |
|--------------------------|--------------|------------------|



- Adjustable handlebar mounted convex mirrors.
- The convex surface allows improved visibility with a wider field of view.
- Doesn't require a windshield or fairing to be mounted.

SEATS

| | | |
|------------------------|----------------------------------|------------------|
| Driver Backrest | G2L (except MAX models) | 715003941 |
| | G2 (except 6x6 & MAX models) | 715003940 |
| | G2 (6x6 models only, except MAX) | 715003611 |



- Provides the rider's back with that extra support that makes riding that extra mile way more comfortable.
- Adjusts horizontally to match the driver's height and preference.
- Mounts and locks in firmly onto the vehicle.

| | | |
|---|-------------------------------------|------------------|
| Outlander Max Passenger Seat Kit | G2 2015 & up, G2L (MAX models only) | 715002373 |
|---|-------------------------------------|------------------|



- Perfect to replace used or damaged passenger seat.

| | | |
|------------------------------|---------|------------------|
| Heavy-Duty Seat Cover | G2, G2L | 715007212 |
|------------------------------|---------|------------------|



- Heavy-duty materials to cover and protect the seat.
- Abrasion- and tear-resistant.
- Simply installs by stretching around the original seat; the elastic holds the cover securely in place.

PLASTIC SKID PLATES

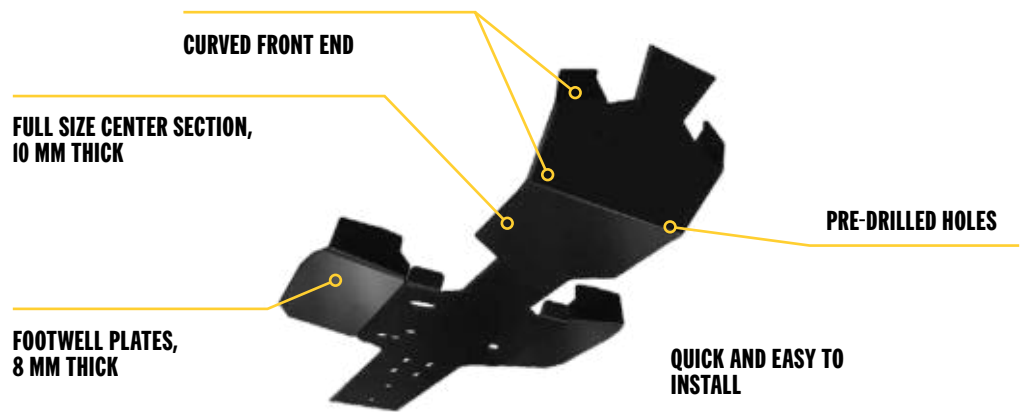
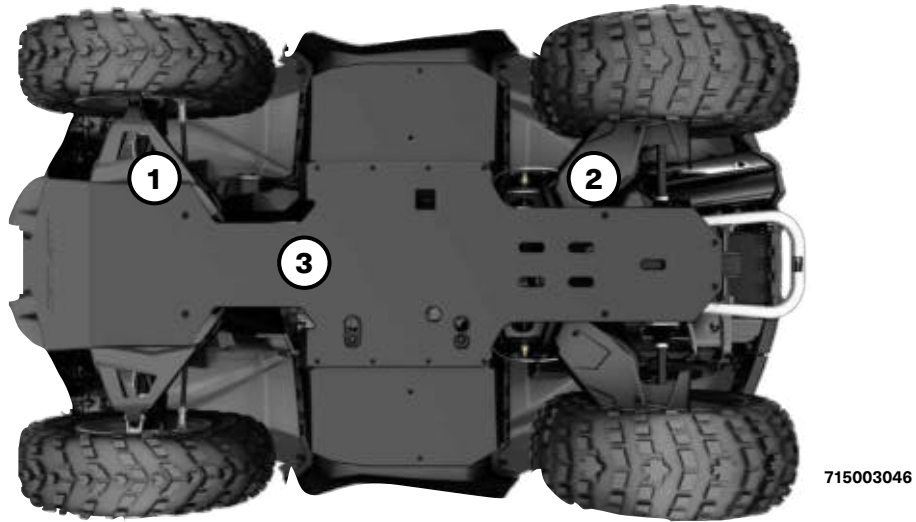

Our Plastic Plates glide smoothly and silently over obstacles, offering great protection in rough terrain. Made of abrasion-resistant thermoformed High Molecular Weight Polyethylene (HMWPE).

- Lighter than aluminum.

| Offer your Outlander & Renegade the full protection kit or get them individually | OUTLANDER | OUTLANDER MAX | OUTLANDER 6X6 | G2, G2S | G2L | G2L MAX |
|--|-----------|---------------|------------------------------|-----------|-----------|-----------|
| INDIVIDUAL PLASTIC SKID PLATES | | | | | | |
| ① A-ARM PROTECTORS G2 | 715002924 | 715002924 | 715002924 | 715002924 | — | — |
| ② TRAILING ARM PROTECTORS G2 | 715002925 | — | 715002925 | 715002925 | — | — |
| ③ PLASTIC SKID PLATE G2 | 715006019 | 715006020 | 715005290 715005320 (MAX) | — | 715006115 | 715006116 |

HMWPE SKID PLATES

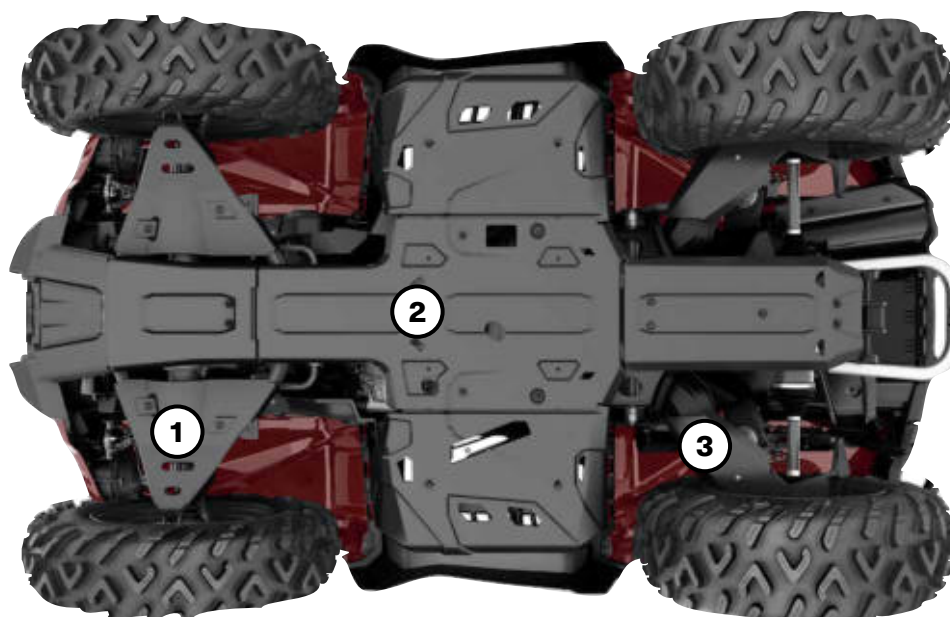

Our plastic plates glide smoothly and silently over obstacles, offering great protection in rough terrain. Made of ¼" (6 mm) thick abrasion-resistant thermoformed High Molecular Weight Polyethylene (HMWPE).

- Lighter than aluminum.
- Superior stress crack resistance.
- High impact strength.

OUTLANDER, RENEGADE

| G2 | | | | | | G2L | | G2S | |
|--------------------------------|------------------------------|--------------------------------|------------------------------|--------------------------------|------------------------------|-------------------|-----------------|------------------|-----------|
| 2016 & Prior | | 2017-2018 | | 2019 & Up | | | | 2017-2018 Models | 2019 & Up |
| Except MAX & X mr 1000R models | MAX & X mr 1000R models only | Except Max & X mr 1000R models | MAX & X mr 1000R models only | Except MAX & X mr 1000R models | MAX & X mr 1000R models only | Except MAX models | MAX models only | | |

HMWPE Skid Plate Protection Kit

| | | | | | | | | | |
|-----------|-----------|-----------|-----------|-----------|-----------|-----------|-----------|-----------|-----------|
| 715004214 | 715004215 | 715004209 | 715004210 | 715004806 | 715004807 | 715004211 | 715004212 | 715004213 | 715004809 |
|-----------|-----------|-----------|-----------|-----------|-----------|-----------|-----------|-----------|-----------|

Individual HMWPE Skid Plates

| | 2016 & Prior | 2017-2018 | 2019 & Up | 2019 & Up | 2019 & Up | 2019 & Up | 2019 & Up | 2019 & Up | 2019 & Up | 2019 & Up |
|---|--------------|-----------|-----------|-----------|-----------|-----------|--------------------------------------|--------------------------------------|-----------|-----------|
| ① A-Arm Protectors | 715002924 | 715002924 | 715002924 | 715002924 | 715004822 | 715004822 | 715002924 | 715002924 | 715002924 | 715004822 |
| ② Underbelly Plates <i>Footwell portion not compatible with Renegade X mr</i> | 715002926 | 715002927 | 715002926 | 715002927 | 715002926 | 715002927 | 715002928 | 715002929 | 715002974 | 715002974 |
| ③ Trailing Arm Protectors | - | - | 715003466 | 715003466 | 715004823 | 715004823 | 715003466 (2015 to 2020 models only) | 715003466 (2015 to 2020 models only) | 715003466 | 715004823 |

ALUMINUM SKID PLATES

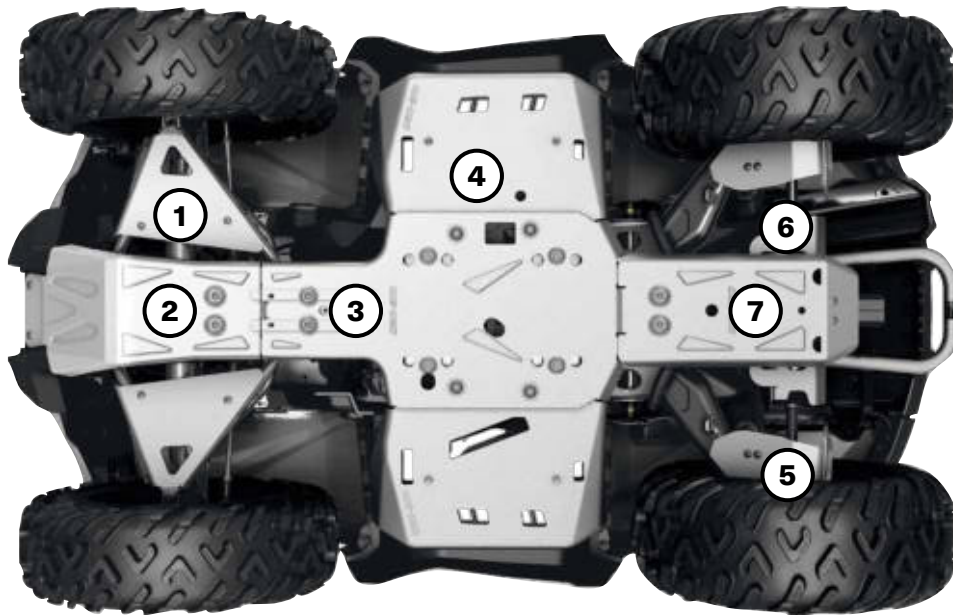

For ultimate durability and strength, all our Aluminum Skid Plates are made with $\frac{3}{16}$ " (4.5 mm) thick High Strength 5052 H32 Aluminum.

- Ultimate durability.
- High strength.

OUTLANDER

| | G2 | | | | | | G2L | |
|---|--------------------------------|------------------------------|--------------------------------|------------------------------|--------------------------------|------------------------------|-------------------|-----------------|
| | 2016 & prior | | 2017-2018 | | 2019 & up | | Any year | |
| | Except MAX & X mr 1000R models | MAX & X mr 1000R models only | Except MAX & X mr 1000R models | MAX & X mr 1000R models only | Except MAX & X mr 1000R models | MAX & X mr 1000R models only | Except MAX models | MAX models only |
| Aluminum Skid Plate Protection Kit | 715002137 | 715002138 | 715004197 | 715004198 | 715004804 | 715004805 | 715004199 | 715004200 |
| Individual Aluminum Skid Plates | | | | | | | | |
| ① A-Arm Protectors | 715001667 | 715001667 | 715001667 | 715001667 | 715004820 | 715004820 | 715001667 | 715001667 |
| ② Front Skid Plate | 715000926 | 715000926 | 715000926 | 715000926 | 715000926 | 715000926 | 715001906 | 715001906 |
| ③ Central Skid Plate | 715002078 | 715002078 | 715002078 | 715002078 | 715002078 | 715002078 | 715002078 | 715002078 |
| ④ Footwell Protector Plates | 715000922 | 715000922 | 715000922 | 715000922 | 715000922 | 715000922 | 715000922 | 715000922 |
| ⑤ Trailing Arm Protectors | — | — | 715008595 | 715008595 | 715004821 | 715004821 | 715008595 | 715008595 |
| ⑥ Rear Differential Protectors | 715000920 | 715000920 | 715000920 | 715000920 | 715000920 | 715000920 | 715000920 | 715000920 |
| ⑦ Rear Skid Plate | 715002028 | 715002029 | 715002028 | 715002029 | 715002028 | 715002029 | 715002028 | 715002029 |

ALUMINUM SKID PLATES



For ultimate durability and strength, all our Aluminum Skid Plates are made with $\frac{3}{16}$ " (4.5 mm) thick High Strength 5052 H32 Aluminum.

- Ultimate durability.
- High strength.

RENEGADE

G2S

| | 2016 & prior | 2017-2018 | 2019 & up |
|---|--------------|-----------|-----------|
| Aluminum Skid Plate Protection Kit | | | |
| <i>Not compatible on X mr models</i> | 715002139 | 715004201 | 715004808 |
| Individual Aluminum Skid Plates | | | |
| ② A-Arm Protectors | 715001667 | 715001667 | 715004820 |
| ② Front Skid Plate | 715000925 | 715000925 | 715000925 |
| ③ Central Skid Plate | 715002078 | 715002078 | 715002078 |
| ④ Footwell Protector Plates <i>Not compatible on X mr models</i> | 715001359 | 715001359 | 715001359 |
| ⑤ Trailing Arm Protectors | 715001129 | 715008595 | 715004821 |
| ⑥ Rear Differential Protectors | 715000920 | 715000920 | 715000920 |
| ⑦ Rear Skid Plate | 715002028 | 715002028 | 715002028 |

HMWPE & ALUMINUM SKID PLATES

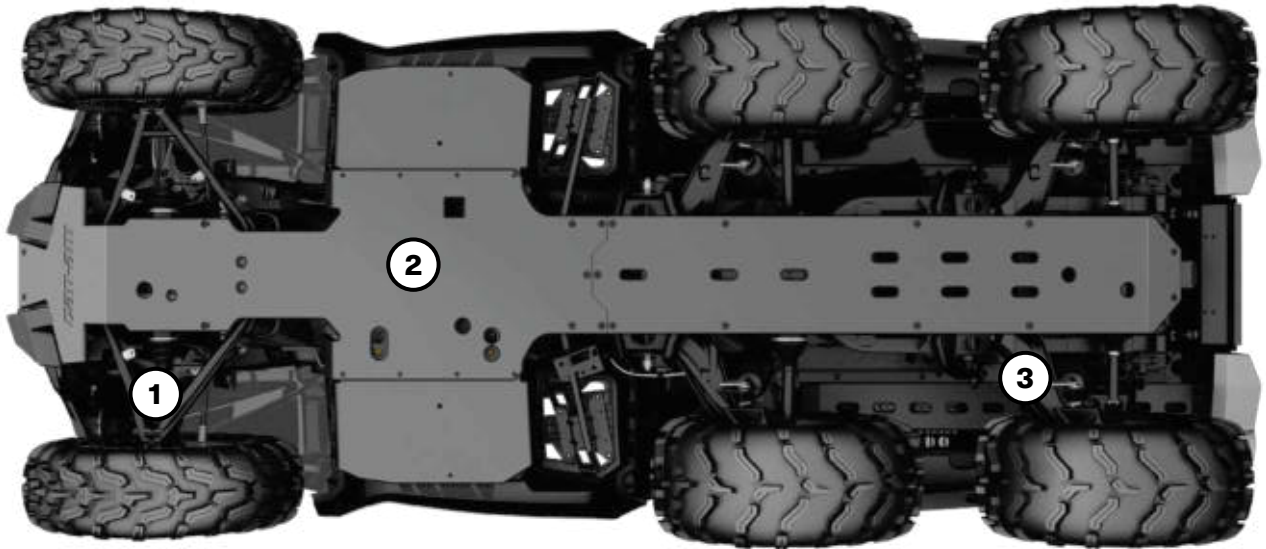

Our Plastic and Aluminum Plates glide smoothly and silently over obstacles, offering great protection in rough terrain.

HMWPE

Made of ¼" (6 mm) thick abrasion resistant thermoformed High Molecular Weight Polyethylene (HMWPE).

- Lighter than aluminum.
- Superior stress crack resistance.
- High impact strength.

ALUMINUM

Made with High Strength ¾" (4.5 mm) thick 5052 H32 Aluminum.







- Ultimate durability.
- High strength.

OUTLANDER 6X6

| | G2 6x6 | | | G2L 6x6 |
|--|---------------------------|-------------|---------------------------|---|
| | 2016 & prior | 2017 - 2018 | 2019 & up | Any year |
| Individual HMWPE Skid Plates | | | | |
| ① HMWPE A-Arm Protectors | 715002924 | 715002924 | 715004822 | 715002924 |
| ② HDPE Full Underbelly Skid Plate | 715005290 (except Max) | 715005290 | 715005290 (except Max) | 715004987 (except MAX) |
| | 715005320 (Max Only) | 715005320 | 715005320 (Max Only) | 715005259 (Max Only) |
| ③ HMWPE Trailing Arm Protectors | - | 715003466 | 715004823 | 715003466 (2020 models & prior only) |
| Individual Aluminum Skid Plates | | | | |
| ① Aluminum A-Arm Protectors | 715001667 | 715001667 | 715004820 | 715001667 |
| ② Aluminum Full Underbelly Skid Plate | | | | |
| ③ Aluminum Trailing Arm Protectors | | 715008595 | 715004821 | 715008595 |

BUMPERS & GUARDS

Bumpers

| | | |
|--|--|------------------|
| Expedition Front Bumper | G2, G2L (except X mr models & X xc models 2022 & up) | 715007233 |
|  | <ul style="list-style-type: none"> • Made of 1.5" profiled steel tubes for complete protection of the vehicle's front. • Protects and doesn't obstruct the vehicle's headlights. • Integrated mounting spots for lights. • Inside and outside anticorrosion coating with a durable powder coat finish. | |
| Expedition Rear Bumper | G2, G2L | 715007234 |
|  | <ul style="list-style-type: none"> • Made of 1.5" profiled steel tubes for complete protection of the vehicle's rear. • Protects and doesn't obstruct the vehicle's taillights. • Inside and outside anticorrosion coating with a durable powder coat finish. • G2 base and DPS rear bumper installation requires 705008164 and 705008165. | |
| NEW X mr Front Bumper | G2S 2023 & up | 715008198 |
|  | <ul style="list-style-type: none"> • Enhanced vehicle front protection. Required as a mounting point for Radiator Relocator (715008898). | |
| XT Front Bumper | G2 | 715004837 |
|  | <ul style="list-style-type: none"> • Provide additional protection against obstacles. • Tough and durable, can be added on base Outlander model to convert vehicle into XT model. • Standard on XT, XT-P, Mossy Oak and Limited models. • Large tube construction with textured black finish and metal corners. | |
| XT Rear Bumper | G2 | 715004920 |
|  | <ul style="list-style-type: none"> • Provide additional protection against obstacles. • Tough and durable, can be added on base Outlander model to convert vehicle into XT model. • Standard on XT, XT-P, Mossy Oak and Limited models. • Large tube construction with textured black finish and metal corners. | |
| XT Front Bumper | G2L | 715001910 |
|  | <ul style="list-style-type: none"> • Winch compatible. • Large tube construction. • Protects vehicle against obstacles. • Standard on XT models. | |
| XT Rear Bumper | G2L | 715001911 |
|  | <ul style="list-style-type: none"> • Large tube construction. • Protects vehicle against obstacles. • Standard on XT models. | |

Extreme Front Bumper

G2
G2L

715001286*
715004279



- Ultra-sturdy build.
- Enhances front-vehicle protection.
- Compatible with XT Front Bumper.
- Fits the Apache™ 360 Track System (when side panels are removed).
- Not compliant with T-category models.
- *Not compatible with Front Hitch.

Complete Rancher Protection Kit

G2, G2L (except X mr & 6x6 models)

715003463



- These heavy-duty bumpers and fender guards are designed to pull double duty: protect your ATV and anything it comes in contact with, while also enhancing the look of your ATV.
- Made tough and designed to deliver a rugged appearance, together they offer front, rear and full side protection for farmer, rancher and forestry applications.
- Requires Body Side Protector Extensions (715003460) for installation on MAX models.
- This kit includes:
 - Rancher Front Bumper (715003461).
 - Rancher Rear Bumper (715003462).
 - Body Side Protector (715003459).
- Not compliant with T-category models

Rancher Front Bumper

G2, G2L (except X mr models)

715003461



- The low front end protection and plates allow you to use your ATV within cattle herds and guard the safety of both the vehicle and the animals.
- The flat front portion facilitates gently prodding cattle or pushing light objects, e.g. closing a fence.
- The full frontage coverage extends to provide an extra layer of defense to your headlights and radiator.
- Inside and outside anti-corrosion coating with durable powder coat finish.
- Not compatible with track systems, plows and front hitch.
- Not compliant with T-category models

Rancher Rear Bumper

G2, G2L (except 6x6 models)

715003462



- Ideal for using your ATV within cattle herds and guarding the safety of both the vehicle and the animals.
- Coverage extends to provide an extra layer of defense to your tail lights.
- Inside and outside anti-corrosion coating with durable powder coat finish.
- Not compatible with track systems.
- Not compliant with T-category models.

Renegade Extreme Front Bumper

G2S 2022 and prior (except X mr models)

715002469



- Enhanced vehicle front protection.
- Required as a mounting point for Radiator Relocator (715008898).

Guards

Body Side Protector

G2 2012 to 2018 with stock XT Bumper, G2 2012 & up with Rancher Bumper, G2L with Rancher Bumper, (except X mr and 6X6 models)

715003459

G2 2019 & up with XT Bumpers, (except X mr and 6X6 models)

715004940*

G2L with XT Bumpers, (except X mr and 6X6 models)

715003614



- The heavy-duty fender guard designed to pull double duty, protecting your ATV and also enhancing the look of your ATV.
- Made tough and designed to deliver a rugged appearance, this fender guard offers full side protection for farmer, rancher and forestry applications.
- Built of durably bold 1.25" (3 cm) diameter steel-tube construction, with inside and outside anti-corrosion coating with durable powder coat finish.
- Not compatible with Self Clearing Footwell.
- XT Front and Rear Bumpers or Rancher Front and Rear Bumpers are required for installation.
- Requires Body Side Protector Extensions (715003460) for installation on MAX models.

*Not compatible with Front and Rear Rancher Bumpers.

Body Side Protector Extensions

(Not illustrated)

G2, G2L (MAX models only)

715003460

- This specially designed extension for the Body Side Protector is made specifically to fit and seamlessly integrate into the look of Outlander MAX models.

| | | |
|------------------|-------------------------------|------------------|
| Mud Flaps | G2 (with stock fender flares) | 715007089 |
|------------------|-------------------------------|------------------|



- Keeps mud, snow and debris out of cargo area and protects trailer and vehicles behind you.
- Adds aesthetic appearance to your vehicle.
- Requires stock fender flare.
- Sold in pairs.

| | | |
|----------------------|--|---------------------|
| | G2 2012-2018 (except with 30" tires) (except 6x6 models) | 715001764* |
| | G2 2019 & up (with 30" tires) (except 6x6 models) | 715004250** |
| | G2L | 715001909*** |
| Fender Flares | G2L European vehicles only 2015 & up | 715004487 |



- Kit designed to deliver extra protection from dirt and debris, therefore a must if you enjoy riding in the mud.
- Made of injected plastic that hugs your vehicle fenders perfectly.
- Gives vehicle added flair for that rugged cool look.
- Includes front and rear extensions and all mounting hardware.

**Comes stock on G2 models 2019 & up (except X mr models).*

***Standard on G2 X mr 1000R.*

****Not compatible with European vehicles.*

| | | |
|--------------------------------|------------------------|--------------------|
| | G2 (except 6x6 models) | 715005111* |
| Fender Flare Extensions | G2L | 715003615** |



- Block terrain debris from kicking up onto you as you ride or damaging your vehicle thanks to these extra-large Fender Flare Extensions, which also include mud flaps for added protection from mud/snow, especially when riding with track kits.
- Made of High Molecular Weight Polyethylene (HMWPE) for advanced abrasion resistance.
- Include front and rear extensions.

**Must be used with Fender Flare for G2 (715001764).*

***Must be used with Fender Flare for G2L (715001909).*

| | | |
|----------------------|--------------------------|------------------|
| Fender Flares | G2S (except X mr models) | 705012695 |
|----------------------|--------------------------|------------------|



- Integrated extended Fender Flares for sporty look and full body protection from dirt and water.
- Include front and rear extensions and all mounting hardware.

| | | |
|---------------------------------|----------------------|------------------|
| Flatbed Protection Tubes | G2 (6x6 models only) | 715002030 |
|---------------------------------|----------------------|------------------|



- Bolt-on bumpers for the sides of the 6x6 flatbed.
- Protect the exterior plastic components of the flatbed from rocks, trees and other obstacles when traversing enclosed areas or loading cargo onto the bed.

| | | |
|---------------------------------|-----------------------|------------------|
| Flatbed Protection Tubes | G2L (6x6 models only) | 715005266 |
|---------------------------------|-----------------------|------------------|





- Bolt-on bumpers for the sides of the 6x6 flatbed.
- Protect the exterior plastic components of the flatbed from rocks, trees and other obstacles when traversing enclosed areas or loading cargo onto the bed.

LIGHTS & ELECTRICAL

| | | |
|--|---|--|
| Integrated Heated Grips & Thumb Throttle Combo | G2, G2L, G2S (2021 & up) | 715005072 |
|  | <ul style="list-style-type: none"> Heat levels for grips and thumb displayed on vehicle screen. Ergonomic button integrated on LH grip. Single button for both grips and thumb heat selection. Five temperature settings for the thumb and grips. Adjustable heat ratio between grip and thumb warmer. | <ul style="list-style-type: none"> Hold button to reach maximum heat quickly. Remembers your last heat setting. IP67-rated waterproof sealing keeps the elements out. ECE compliant. Plug-and-play installation. Clamp-on grips, no glue required. |
| Heated Grips & Thumb Throttle Combo | <p>G2, G2L, G2S (except 2020 & up models equipped with 850 engine and 2019 & up models with 1000R engine, T Category models)</p> <hr/> <p>G2, G2L, G2S (2020 & up models equipped with 850 engine and 2019 & up models with 1000R engine, T Category models)</p> | <p>715003250 Not compatible with Intelligent Throttle Control (ITC)</p> <hr/> <p>715008739* Compatible with Intelligent Throttle Control (ITC)</p> |
|  | <ul style="list-style-type: none"> LED dimmer facilitates reading temperature settings. 4 temperature settings with individual controls for thumb and grips. Returns to previous heat setting. <p><i>*Relocation bracket (715007619) required for installation on T-category models & G2L XU (INTL model)</i></p> | <ul style="list-style-type: none"> One-touch shutdown. Wiring Cable is required for installation on G2L models only. |
| Wiring Cable <i>(Not illustrated)</i> | G2L | 710004567 |
| <ul style="list-style-type: none"> Required for installation of Heated Hand Grips & Throttle Combo. | | |
| Heated Visor Outlet | G2, G2L | 715001246 |
|  | <ul style="list-style-type: none"> Strategically positioned on vehicle to maintain your agility. Optional visor outlet that delivers fog-free riding. Quick and easy installation. Sold individually. Heated Visor not included. | |
| Heated Passenger Grips & Visor Outlet | G2, G2L (MAX models only) | 715008794 |
|  | <ul style="list-style-type: none"> Replace your stock passenger handles. Dual temperature switch integrated into seat arm for 3-zone heated handles and grips. Heated visor outlet integrated into seat arm. | |
| USB Power Outlet Kit | G2, G2L, G2S | 219400510 |
|  | <ul style="list-style-type: none"> Recharges your electronic devices while riding (smartphone, MP3, heating gear, etc.). Dual port USB connectors. The power outlet is not capable of recharging all device types while riding. | |
| Seat Heater | G2, G2L | 715007211 |
|  | <ul style="list-style-type: none"> 25 W seat heater delivers chill-free riding comfort. One temperature only. Heated pad and electrical harness only. Heavy Duty Seat Cover (715007212) is required for the installation. | |
| Engine heater | <p>605154278</p> <hr/> <p>715002043</p> | |
| <ul style="list-style-type: none"> Outlander 500 / 570 / 650 / 800 (G1/G2) Outlander 1000 (G2) | | |

| | | |
|--|---|---|
| Electronic Device Holder | G2, G2L (except 6x6 & X mr models) | 715004919 |
|  | <ul style="list-style-type: none"> Robust injected-polypropylene construction allows for the right fit and easy installation. Adjustable unit safely holds smartphones or small tablets with a length or width measuring between 2.9" (7.5 cm) and 5.1" (13.0 cm) with or without protective case. Integrated storage (0.6 gal / 2.1 L). | <ul style="list-style-type: none"> Guiding wire grooves to pass charging cable through the lid. Possibility of relocating 12V power outlet or installing USB outlet in storage compartment (USB power outlet sold separately). Not compatible with windshields or Snorkel Kit. |

| | | |
|---|--|--|
| 3.5" (9 cm) LED Lights (2 X 14W) LED Driving Lights | G2, G2L (except X mr models) | 715003666 |
|  | <ul style="list-style-type: none"> 14W LED lights producing 1,260 lumens each. Equipped with 6 high power LEDs in a heavy-duty die cast aluminum housing. Features 2 attachment points — if one attachment point fails due to a collision, rotate to the next channel point and re-mount the light. | <ul style="list-style-type: none"> Sold in pairs. EC compliant. Spot lens for a narrow and long light beam spread, ideal when driving at higher speeds. Expedition Front Bumper (715007233) and Light Power Cable (715007275) required for installation. |

| | | |
|---|--|---|
| 3.5" (9 cm) LED Lights (2 X 14W) LED Flood Lights | G2, G2L (except X mr models) | 715003665 |
|  | <ul style="list-style-type: none"> 14W LED lights producing 1,260 lumens each. Equipped with 6 high power LEDs in a heavy-duty die cast aluminum housing. Features 2 attachment points — if one attachment point fails due to a collision, rotate to the next channel point and re-mount the light. | <ul style="list-style-type: none"> Sold in pairs. EC compliant. Flood lens for a wide light beam spread, ideal for working applications like plowing or for cornering, dusty or foggy riding conditions. Expedition Front Bumper (715007233) and Light Power Cable (715007275) required for installation. |

| | | |
|--|---|---|
| 4" (10 cm) Round LED Lights (2 x 25 W) | G2, G2L (except X mr models) | 715002935 |
|  | <ul style="list-style-type: none"> 25 W LED spotlights. 1,800 lumens. Rugged and waterproof. Includes basic wiring and switch. Can-Am branded grill. | <ul style="list-style-type: none"> Sold in pairs. Not EC compliant. Expedition Front Bumper (715007233) and Light Power Cable (715007275) required for installation. |

| | | |
|---|--|---|
| 10" (25 cm) Double Stacked LED Light Bar (60 Watts) | G2, G2L (except X mr models) | 715002933 |
|  | <ul style="list-style-type: none"> Equipped with 12 5W Cree LEDs. 5,400 lumens. Rugged and waterproof. Packs a big punch for its size. | <ul style="list-style-type: none"> EC compliant. Expedition Front Bumper (715007233) and Light Power Cable (715007275) required for installation. |

| | | |
|--|---------|------------------|
| Light Power Cable <i>(Not illustrated)</i> | G2, G2L | 715007275 |
| <ul style="list-style-type: none"> Required for installation of the 10" (25 cm) LED Light Bar, the 3.5" (9 cm) and 4" (10 cm) LED Lights. | | |

| | | |
|--|---|--|
| Bluetooth Handlebar Soundbar by Mtx | G2, G2L, G2S | 219400840 |
|  | <ul style="list-style-type: none"> Bluetooth speaker with the unbeatable convenience of fingertip control. Rugged IP66-rated weather-resistant speaker designed for outdoor use. Driven by 150 watts of quality audio power. Seamless integration and operation from Bluetooth enabled devices. | <ul style="list-style-type: none"> Includes input, ground and ignition wires, plus auxiliary port and 3.5" (8.89 cm) connector cable. Not compatible with XT Handlebar Protector Kit. EC compliant. <p><i>Note: We recommend you use 320 Kbps MP3 - 192-256 Kbps AAC or AIFF, WAV formats to match the potential of the speaker. More compressed formats will probably have degraded sound quality.</i></p> |

| | | |
|---|--|------------------|
| Multi Position Light Mount Kit | G2, G2L, G2S | 715004274 |
|  | <ul style="list-style-type: none"> Multi-position plastic clamps that fit on various tubing sizes: 0.75" to 1.5" (19 mm to 38 mm). Required for the installation of the 2" (5 cm) Square LED Lights (2 x 10W). Kit includes tube clamp mounts and power cables. | |

Baja Designs High Beam Kit

G2 (2022 and prior)

715004284

- Thanks to their direct bolt-on and plug-and-play installation right into the original high beam location, upgrading from your stock high beam lights to these powerful Baja Designs Squadron Pro LED Lights becomes child's play.
- Each spot is equipped with 4 Cree LEDs producing 4,900 lumens at 40 watts.
- Driving/Combo light pattern for smooth blend of light for both near field applications and distance.
- Not EC compliant.

2" (5 cm) Square LED Lights (2 X 10 Watts)

G2, G2L, G2S

715004293

- 2 x 900 lumens 10W LED Cree light kit.
- Long-range illumination up to 350' (107 m), drawing less than 1 amp per light.
- Multi-Position Light Mount Kit is required for installation.
- Not EC compliant.

RAM⁺ LED Spotlight

G2, G2L, G2S

710005423

- 540 lumens LED light (9W) heavy-duty spotlight standard-equipped with 1" (2.5 cm) diameter rubber-coated double ball and socket system.
- Not EC compliant.

Center Console Day Light

G2S (except X mr)

715000691

- Mountable on top end of center console.
- Enhances look of vehicle.

Battery Charger/Maintainer**715005061**

- Keeps stored lead-acid batteries charged.
- Charges and maintains small batteries.
- Microprocessor controlled multi-stage charging for added precision, safety and battery life.
- Automatically detects 6- or 12-volt batteries.
- Reverse hook-up protection helps protect battery and charger from damage.
- Auto-voltage detection.
- Press the display button to show the charge progress.
- Content: 3 amp battery charger, clamp adapter, DC adapter, 24" (61 cm) fused ring leads harness with weather cap, owner's manual.
- Not EC compliant.
- US plug (110V).
- Not available in Europe.

Jump Starter**715005062**

- IPX3 water-resistant and enclosed output ports.
- 4 LED battery indicators for easy read on battery charge level.
- Compact design, will conveniently fit in your backpack, glove box or any other storage compartment.
- 2.4A + 1A/5V USB ports for fast charging of all USB devices.
- Smart cable provides protection against reverse polarity, short circuit, low voltage, high temperature and reverse charging.
- Built-in LED light (3 modes).
- Content: 300CA jump starter, SA858 smart cable clamp, MC-USB to USB charging cable, travel bag, user manual.
- Not EC compliant.
- Not available in Europe.

Quick Connect Battery Cable**715005408**

- Quickly and easily connect and charge different items with your charger.
- Included in the Battery Charger/Maintainer (715005061).
- Sold individually.
- Not available in Europe.

C-TEK charger**860200997**

- CTEK, the manufacturer of the smartest battery chargers in the world, has produced a BRP specific charger for all BRP products.
- Charger is built to meet the demanding arctic conditions.
- Ask your dealer for more information.

Quick Connect Cable with Battery Indicator

715006055

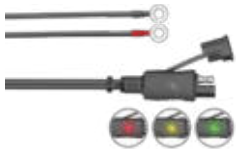

- Quickly and easily connect and charge different batteries with your charger.
- 3-color LED indicator provides constant battery health indication.
- Sold individually.
- Not available in Europe.

GPS RAM® Mount for Handlebar

G2, G2L, G2S

715001985
While supplies last



- Convenient bracket for installing the Garmin Montana GPS (not included) onto your unit's handlebar.

**Digitally Encoded Security System (D.E.S.S.)
Green Key**

G2, G2S (2018 & up)

710005232



- Anti-theft technology, Digitally Encoded Security System (D.E.S.S.) key snaps easily on the vehicle and provides riders easy and quick starts every time.
- The key communicates with the vehicle wirelessly so the vehicle starts only when the key code matches the vehicle, for ultimate peace of mind.
- The Programmable D.E.S.S. Key can also be programmed to 3 modes:
 - Work mode: Limits vehicle speed to 40 kph (25 mph) but does not limit engine torque.
 - Normal mode: Limits vehicle speed to 70 kph (44 mph) and 50% torque reduction.
 - Performance mode: No restrictions.

WINCHES

Can-Am HD Winches

Can-Am HD 2500 Winch

G2, G2L

715006414



- Heavy-duty four-way roller fairlead.
- Ergonomic clutch handle.
- Rugged all-steel gears and bushings provide more torque and longer life.
- Automatic 100% load-holding brake.
- Sealed solenoid for all-weather protection.
- Wired Remote Control sold separately.
- Plug-and-play wiring and attachment brackets.
- Weather-sealed handlebar-mounted switch.
- Pulling strength capability of 2,500 lb (1,134 kg).
- 50 ft. of 3/16" (15.2 m of 4.8 mm) wire steel cable.
- EC-compliant.

Can-Am HD 3500 Winch

G2, G2L

715006415



- Heavy-duty four-way roller fairlead.
- Ergonomic clutch handle.
- Rugged all-steel gears and bushings provide more torque and longer life.
- Automatic 100% load-holding brake.
- Sealed solenoid for all-weather protection.
- Wired Remote Control sold separately.
- Plug-and-play wiring and attachment brackets.
- Weather-sealed handlebar-mounted switch.
- Pulling strength capability of 3,500 lb (1,588 kg).
- 50 ft. of 3/16" (15.2 m of 4.8 mm) wire steel cable.
- EC-compliant.

WARN† VRX Winches

WARN VRX 25 Winch

G2, G2L, G2S

715006107



- Extreme IP68-rated waterproof sealing keeps the elements out.
- Durable all-metal construction.
- Black powder-coated finish and stainless-steel fasteners for corrosion resistance.
- Robust new clutch design based on 70+ years of WARN 4WD hub lock know-how.
- Handlebar-mounted rocker control.
- Load-holding brake for great control.
- Smooth and reliable all-metal three-stage planetary gear train.
- Limited lifetime warranty (mechanical), 3-year warranty (electrical).
- Pulling strength capability of 2,500 lb (1,134 kg).
- 50 ft. of 3/16" (15 m of 4.8 mm) wire steel cable.
- Roller fairlead.
- Wire harness (715002453) required for installation.
- Winch mounting plate is required for G2S (STD & X xc 2022 & prior only).
- EC-compliant.

WARN VRX 35 Winch

G2, G2L, G2S

715006108



- Extreme IP68-rated waterproof sealing keeps the elements out.
- Durable all-metal construction.
- Black powder-coated finish and stainless-steel fasteners for corrosion resistance.
- Robust new clutch design based on 70+ years of WARN 4WD hub lock know-how.
- Handlebar-mounted rocker control.
- Load-holding brake for great control.
- Smooth and reliable all-metal three-stage planetary gear train.
- Limited lifetime warranty (mechanical), 3-year warranty (electrical).
- Pulling strength capability of 3,500 lb (1,361 kg).
- 50 ft. of 7/32" (15 m of 5.5 mm) wire steel cable.
- Roller fairlead.
- Wire harness (715002453) required for installation.
- Winch mounting plate is required for G2S (STD & X xc 2022 & prior only).
- EC-compliant.

WARN VRX 35-S Winch

G2, G2L, G2S

715006109



- Extreme IP68-rated waterproof sealing keeps the elements out.
- Durable all-metal construction.
- Black powder-coated finish and stainless-steel fasteners for corrosion resistance.
- Robust new clutch design based on 70+ years of WARN 4WD hub lock know-how.
- Handlebar-mounted rocker control.
- Load-holding brake for great control.
- Smooth and reliable all-metal three-stage planetary gear train.
- Limited lifetime warranty (mechanical), 3-year warranty (electrical).
- Pulling strength capability of 3,500 lb (1,361 kg).
- 50 ft. of 3/16" (15 m of 4.8 mm) synthetic rope.
- Cast aluminum fairlead.
- Wire harness (715002453) required for installation.
- Winch mounting plate is required for G2S (STD & X xc 2022 & prior only).
- EC-compliant.

Rear winch kit

G2 (except 6x6 models)

715007100

G2 (6x6 models only)

715006503

G2L (6x6 models only)

715007099



- The remote-controlled rear winch is a godsend when you want to pull yourself out of a tough spot or move heavy loads.
- Includes a fully-sealed Warn winch and all wiring and hardware needed for an easy and quick installation.
- Pulling strength capability of 3,000 lb (1,361 kg).
- 50 ft. of 7/32" (15.2 m of 5.5 mm) wire steel cable.

Winches Accessories

Wireless Remote Control

WARN Winches

715002542



- The system is quick and easy to install, thanks to a wiring harness with an integrated antenna and all necessary mounting hardware.
- The system allows you to operate your winch from anywhere within a 50' (15.2 m) radius, increasing your recovery options.
- All components are weatherproof.

Wired Remote Control

WARN Winches

715006378

Can-Am HD Winches (715006414 & 715006415)

715006555

Can-Am HD Winches (715008140 & 715008141)

715008121



- This kit allows winch owners to add the hand-held remote to their winch.
- This kit allows winch owners to add the handheld remote to vehicles with a stock winch.
- Works in conjunction with the mini-rocker switch.
- Wired Remote & Remote Socket included.
- EC-compliant.

Winch Accessories Kit

715002409



- Get the most out of your winch.
- Double your pulling power, change your pulling direction and keep your winch in proper working order.
- Includes tree straps, snatch block, shackle and winching gloves.

WARN Hawse Fairlead

WARN Winches

715007698



- Double powder-coated construction.
- Required to use the Synthetic Winch.
- Cable (715004254) on WARN winches.
- To be used with synthetic winch cables only.

Roller Fairlead

WARN Winches

715007699

Can-Am HD Winch

710007459



- Features top, bottom and side rollers for less cable wear and smoother operation from any direction for easier winching.

Hook with Safety Latch & Strap Kit

Can-Am HD Winches

705014949



- Heavy-duty winch-rope hook with stainless steel snap.
- Includes a nylon safety strap.

Replacement Wire Rope – Can-Am HD

705014983

705014984



- Play it safe, always carry a replacement wire rope.
- 2,500 lb (1,134 kg) pulling strength with 50 ft of $\frac{3}{16}$ " (15.2 m of 4.8 mm) wire rope for 705014983.
- 3,500 lb (1,588 kg) pulling strength with 50 ft of $\frac{7}{32}$ " (15.2 m of 5.5 mm) wire rope for 705014984.

Replacement Wire Rope – ATV WARN Winches

715006256



- Play it safe, always carry a replacement wire rope.
- 3,500 lb (1,588 kg) pulling strength.
- 50 ft. of 7/32" (15.2 m of 5.5 mm) aircraft grade steel wire.

Synthetic Winch Cable

ATV WARN Winches

715004254



- Easier to manipulate than steel cable.
- Replaces the original cable on any factory installed WARN winch or sold as an accessory by BRP.
- Kit includes synthetic rope and rock guard sleeve.
- Always use with the new Hawse Fairlead (715007698).
- 50 ft. (15.2 m) of 3/16" (15.2 m of 4.8 mm) synthetic rope.
- 3,500 lb (1,588 kg) pulling strength.

Winch Mounting Plate

G2S

715000927



- Adds functionality to your Renegade.
- Fits Can-Am winches by WARN.

Winch Wire Harness

(Not illustrated)

G2 2021 & up, G2S 2021 & up and G2L

715002453

- Required plug-and-go wiring to install WARN winch only.
- Not required for Can-Am HD winches.

HITCHES

Hitches

Rear Hitch

G2, G2L (except 6x6 models), G2S

715001925



- E-coat finish.
- Fixed hitch ball mounting bracket.
- Provides fixed mounting point for trailer ball to provide vehicle with towing capabilities.
- This hitch offers 1,300 lb (590 kg) of towing capacity.
- Hitch ball not included.

Front and Rear Hitch Drawbar

G2, G2L, G2S

715008350



- Standard on 2" (5 cm) receiver hitch.
- It offers 1,650 lb (750 kg) of towing capacity.
- Hitch ball not included.
- Forged steel.

Front coupling device

T3

705205025

- Required for T3 models.

Multitrailer

619590024

- Bogie wheels updated to be more silent than before and now equipped with grease nipples.
- Product developed for heavy-duty use.
- 100% galvanized steel.
- Specifications: 12 mm polywood base, strong stand, movable attachment points (4 pc), tipping bed, removable sides and 4 pc timber holder.
- Underside of the bogie and frame designed to travel over stones and logs (no sharp edges).
- Bed length: 182 cm
- Bed width: 66 cm bottom / 95 cm top
- Bed height: 60 cm
- Weight: 200 kg with timber holders and sides

Hitches Accessories

Rear Receiver Hitch

G2S 2012 with 800R or 1000 engines G2S 2013 & up, G2L & G2

715005186



- E-coat finish.
- Does not affect ground clearance.
- Trailer ball not included.
- On 4X4 use, this hitch offers 1,500 lb (680 kg) of towing capacity.
- On 6x6 use, this hitch offers 1,654 lb (750 kg) of towing capacity.
- Compliant with European T regulations.
- Not compatible with G2L models with Rear Skid Plates.

Front Receiver Hitch

G2

715000921



- Front receiver hitch for Outlander with or without a winch.
- This hitch offers 1,300 lb (590 kg) of towing capacity.
- Allows you to maneuver your trailer easily in tight, confined areas.
- Hitch bar sold separately.
- Not compatible with Extreme Front Bumper, Rancher Bumper and ProMount Plows.

Rubber Receiver Plug

705204503



- Rubber cap for 2" (5 cm) hitch receiver.

PERFORMANCE

Performance

Renegade Snorkel Kit

G2S (2020 & prior)

715006000

G2S (2021 & up)

715007083



- Comprehensive kit.
- Extended air intakes and CVT exhaust.
- CVT outlet integrates into pod cover.
- Ideal for muddy conditions.

Renegade Radiator Relocator Kit

G2S 2023 & up

715008898

G2S 2022 & prior

715001929



- Relocates radiator to top mount position.
- Prevents cooling performance loss in muddy conditions.
- Uses existing radiator.
- Includes support, hardware and hoses.
- Engineered for easy cooling system bleeding and maintenance.
- Radiator not included.
- Renegade Extreme Front Bumper (715002469) required for G2S 2022 and prior or X mr Front Bumper (715008198) required for 2023 and up for installation (except X mr).

Mud Strap

G2, G2L, G2S

715003053



- Convenient sturdy grab-handle.
- Lets drivers redistribute their weight for improved traction in demanding conditions.
- Not compatible with XT Handlebar Protector Kit (703100352).

Radiator Protector

G2, G2S (except G2S with 500 engine)

715001744

- Metal shield that mounts over radiator face, providing protection from stones and branches.

Outlander Snorkel Kit

G2 2015 & up, G2L (except X mr & 6x6 models)

715005999

- Comprehensive kit.
- Extended air intakes and CVT exhaust.
- CVT outlet integrates into pod cover.
- Must be installed on a vehicle without XT Handlebar Protector Kit.
- Ideal for muddy conditions.
- Not compatible with windshields.

Outlander Snorkel Kit

G2 (X mr models only), G2L (X mr models only)

715002518

- Comprehensive kit.
- Extended air intakes and CVT exhaust.
- CVT outlet integrates into pod cover.
- Must be installed on a vehicle without XT Handlebar Protector Kit.
- Ideal for muddy conditions.
- Not compatible with windshields.
- Raised horn only.
- Provides higher intake.
- For best fit and finish, appropriate gauge support is required.

Outlander Radiator Relocator Kit

G2, G2L (except 6x6 models)

715001930

- Relocates radiator to top mount position.
- Prevents cooling performance loss in muddy conditions.
- Uses existing radiator.
- Includes support, hardware and hoses.
- Engineered for easy cooling system bleeding and maintenance.
- Radiator not included.

X mr Traction Plates

G2 (MAX models only), G2L

715001752

- Provide extra foot grip for driver when riding in extreme mud conditions.
- Help driver maintain ideal riding position to maximize vehicle traction.
- Made of aluminum.
- Not meant for a passenger.

Self-Clearing Footwells

G2 2015 & up, G2L

715004759

- Made from aluminum.
- Replace original footwells.
- Feature large evacuation ports to avoid mud and snow accumulation in footwells.
- Aggressive design for improved traction.
- Not compatible with Body Side Protectors.
- Sold in pairs.

Footpeg Kit

G2, G2L

715001131

- Provides maximum integrated grip and more stability during vigorous riding.
- Kick-up end generates added grip during hard cornering.
- Made of aluminum.
- Sold in pairs.

| | | |
|------------------------------------|--------------|------------------|
| Foam Air Filter by Twinair† | G2, G2S, G2L | 715001333 |
|------------------------------------|--------------|------------------|



- Maximizes performance by increasing air flow throughout RPM range.
- Maintenance-friendly, i.e., just wash, re-oil and re-use after riding in severely dusty/muddy environments.

| | | |
|---------------------------|--|---------------------------------|
| Heavy-Duty Springs | G2 2012-2018 (Base model, DPS, XT, X mr with 650 engine only & Limited – except 6x6) G2S (Base model with 500 & 570 engines only) | 715003199 · Front |
| | G2L (except Mossy Oak, PRO, 6x6 and X mr models) | 715007203 · Front |
| | G2 2012-2018 (Base model, DPS, XT & X mr with 650 engine only – except 6x6) G2S (Base model with 500 & 570 engines only) | 715003200 · Rear |
| | G2 2019 & up (Base, DPS & XT models, except 6x6) | 715005159 · Front & Rear |



- Heavy-duty springs provide enhanced stiffness.
- Perfect for snow clearing and hauling heavy loads.
- Improves handling and helps prevent accidental overturns.
- Kit includes 4 springs.
- Standard on Outlander PRO and Mossy Oak models.

| | | |
|---------------------------|--------------|------------------|
| Front Shock Covers | G2, G2L, G2S | 715500301 |
|---------------------------|--------------|------------------|



- Feature ventilation holes.
- Offer added protection in rough terrain and weather conditions.
- Sold in pairs.

| | | |
|---|--------------------------|------------------|
| Front and Rear Heavy-Duty Shock kits | G2L (4x4 and 6x6 models) | 715007841 |
| | G2L (4x4 and 6x6 models) | 715008136 |

- Stiffer shocks than the standard ones, for Heavy-duty usage.
- Improved load capacity, ground clearance and comfort (front and rear).
- Sold in pairs.

| | |
|---|------------------------------------|
| Extreme Heavy-Duty rear spring set | 715001998 · Fitting into G2 |
|---|------------------------------------|

- E.g. for use with Forest Pro Log Trailer.

Yoshimura

| | | |
|--|------------------------|------------------|
| Yoshimura Slip-On Exhaust – Outlander | G2 (except 6x6 models) | 715005480 |
|--|------------------------|------------------|



- Made from 304-grade stainless steel.
- Better sounding, better looking and lighter than stock muffler.
- USDF/USDA approved spark arrester.
- Non-EPA compliant (for racing application only).
- Not EC compliant.
- Fuel injection system tuning not required.
- Not compatible with CARB & T Category models 2018 & up, NRMM & 650 Engine 2022 & up.
- Not available in Europe.

| | | |
|---|---|------------------|
| Yoshimura Slip-On Exhaust – Renegade | G2S 2012 & up (except 570 engine and X mr models) | 715005481 |
|---|---|------------------|



- Made from 304-grade stainless steel.
- Better sounding, better looking and lighter than stock muffler.
- USDF/USDA approved spark arrester.
- Non-EPA compliant (for racing application only).
- Not EC compliant.
- Fuel injection system tuning not required.
- Not compatible with CARB & T Category models 2018 & up, NRMM & 650 Engine 2022 & up.
- Not available in Europe.

Emergency Accessories

| | |
|----------------------|------------------|
| Emergency Kit | 715006102 |
|----------------------|------------------|



- Complete emergency kit provides all essential equipment and supplies to get out of most unfavorable situations powersport enthusiasts may find themselves in.
- Includes jumper cables, air compressor, tire-repair kit, first-aid kit, ratchet tie-down, duct tape, 3,300 lb (1,500 kg) tow strap, zip-ties and cloth rags.

COVERS, DECALS & ADD-ONS

Trailer Covers



- Heavy-duty canvas made of UV-resistant solution-dyed polyester.
- Protect windshield and colored panels from abrasion.
- All high-abrasion areas are reinforced with a double canvas layer.
- Opening for fuel cap access.
- Weather-resistant trailer cover protects your vehicle during transportation.
- Quick and easy installation.
- Designed to perfectly fit your vehicle with or without Can-Am accessories.

| | |
|-------------------------------------|------------------|
| G2 (except MAX models) | 715001737 |
| G2 (MAX and X mr 1000R models only) | 715001736 |
| G2L (except MAX models) | 715002026 |
| G2L (MAX models only) | 715002025 |
| G2S (except X mr models) | 715000683 |

Storage Covers



- Weather-resistant storage covers.
- For vehicle storage only.
- UV-resistant solution-dyed polyester construction.
- Quick and easy installation.
- Designed to perfectly fit your vehicle with or without Can-Am accessories.

| | |
|---|--|
| G2, G2L, G2 X mr (except 1000), G2L X mr, G2S, G2S X mr | 715001720 |
| G2, G2L (MAX and X mr 1000R models only) | 715001668 |
| G2 (6x6 models only) | 715002492 |
| G2, G2L (except MAX models) | 715005095 (Europe) |
| G2 MAX, G2 X mr 1000, G2L MAX | ■ 715001597 · Mossy Oak Break-Up Country Camo |
| G2 MAX (6x6 models only) | ■ 715001735 · Mossy Oak Break-Up Country Camo |
| G2L (6x6 models only) | 715004488 |
| G2L MAX (6x6 models only) | 715005261 |
| | 715006024 |

Flag



- Make sure everyone knows what you're riding.
- Perfect for the dunes and new riders.
- 8-ft. (2.4 m) length.
- Includes flag mount (715000127).

■ **715000277** · Yellow

Flag Mount

(Not illustrated)

715000127

Bolt-On[†] Retractable Ratcheting Tie-Downs

295101072



- Perfect for transporting your powersport vehicle or securing loads.
- Mounts easily: Bolts on any flat surface (e.g., truck bed or frame).
- 1" x 6' (2.5 cm x 1.8 m) tie-down strap with heavy-duty stitching that delivers a 500 lb (226 kg) working load strength and 1,500 lb (680 kg) break strength.
- Convenient retractable push button automatically slackens, spools and stores away strap, while the ratchet mechanism tightens the strap snugly to secure your vehicle or load into place.
- Rubber ratcheting handle provides firm grip, and the hook is vinyl coated to protect whatever surface it hooks into.
- Sold in pairs.

Ratchet Tie-Downs

■ **715008309**
· Black/Gray



- 400 lb (181 kg) safe working load.
- 1" x 10' (2.5 cm x 3 m) strap with Can-Am, Sea-Doo, and Ski-Doo logos.
- Deluxe ratchet with rubber handle.
- Coated S hooks.
- Pack of 2.

Heavy-Duty Ratchet Tie-Down

715008308



- 1,000 lb (454 kg) safe working load.
- 1.5" x 6' (38 mm x 1.8 m) strap with BRP brands.
- Deluxe ratchet with rubber handle.
- Black-coated clip hooks.
- 12" (300 mm) webbing included.
- Pack of two.

Shifter Lock

G2, G2L

715007337



- Secure the vehicle's shifter by locking it in position.
- Prevents the vehicle from going into neutral without the lock key.

Lockable Gas Tank Cap

G2, G2L, G2S

860200387
619590085 (Scandinavia)



- Protects your fuel.
- Meets EPA requirements.

License Plate Bracket

G2L

715002498

G2S

715001401



- Provides specific area to install license plate.
- Mounts to rear of vehicle.

APACHE TRACK SYSTEMS

Apache Track Systems

Apache Backcountry Track System

G2 (except 6x6 models), G2S, G2L

715005247



- Designed to deliver the best flotation level and deep-snow performance on the market.
- Contact patch is 23% bigger than the Apache 360 LT.
- Impressive added ground clearance of 7" (18 cm), keeps the vehicle out of deep snow.
- Aggressive track design with 2" (5 cm) lug height for maximum traction on snow.
- Apache Backcountry Mounting Kit and engine and air intake pre-filters are required.
- For winter use only.

Idler Wheel Kit

Apache Backcountry Track System (rear tracks only)

860201230 · 141 mm



- Reduces drag and rolling resistance.
- Includes 2 wheels, brackets and hardware.
- Add up to 2 kits per rear track.
- Can extend slider life in hardened snow conditions.

Sliders with Vespel[†] Inserts

Apache Backcountry Track System

503194815



- Use DuPont Vespel inserts for less friction.
- Longer life.
- Can be cut to desired length.
- 8 needed per vehicle.
- Sold individually.

Rail Ice Scratchers

Apache Backcountry Track System

860201728



- Provide additional lubrication in hard and icy conditions.
- Rail mounted, small, light.
- Design expands on coil concept to allow reversing without damage.
- Easily stored when not in use.

Apache 360 & 360 LT

Apache 360 Track System

G2 (except 6x6 models), G2L, G2S

715006323



- Multifunctional tracks perfect for any Can-Am ATV.
- Average ground clearance of 16" (41 cm).
- 1" (2.5 cm) lugs in the front and 1.25" (3.2 cm) in the back.
- Apache 360 & 360 LT Mounting Kit and engine and air intake pre-filters are required.

Apache 360 LT Track System

G2, G2L, G2S

715005103



- Multifunctional tracks designed to support heavy loads and to fit on most Can-Am Off-Road vehicles.
- Front wheel height adjustment provides enhanced attack angle and better performance over rough terrain when raised or increased contact patch for improved flotation when lowered.
- Average ground clearance increase of 4.5" (11.4 cm).
- 1" (2.5 cm) lugs in the front and 1.25" (3.2 cm) in the back.
- Reliable heavy-duty build.
- EC compliant.
- Contact patch is 7 to 9% bigger than the Apache 360's.
- Apache 360 and 360 LT Mounting Kit, Track DPS Module and Engine and air intake pre-filters are required.

Apache 360 LT 6x6

Apache 360 LT (6x6) Track System

G2, G2L (6x6 only)

715005104



- Multifunctional tracks designed to support heavy loads and to fit on most Can-Am Off-Road vehicles.
- Front wheel height adjustment provides enhanced attack angle and better performance over rough terrain when raised or increased contact patch for improved flotation when lowered.
- Average ground clearance increase of 4.5" (11.4 cm).
- 1" (2.5 cm) lugs in the front and 1.25" (3.2 cm) in the back.
- Apache 360 LT Mounting Kit, Track DPS Module and Engine & Pre-Filter Kit are required.
- Reliable heavy-duty build.
- EC compliant.
- Exclusively for the Outlander 6x6.
- Recommended for use on snow only.

Apache Accessories

Apache Backcountry Mounting Kit

(Not illustrated)

G2 2018 & prior, G2S 2018 & prior, G2L

715004830

G2 2019, G2S 2019

715004796

- Required for installation of the Apache Backcountry Track System.
- DPS module and pre-filter are required and sold separately.

Track DPS Module

(Not illustrated)

G2, G2L, G2S

715007338

- An innovative DPS module that ensures speedometer accuracy and optimized steering assist, which make for perfect track control and riding ease.
- Required to install the Apache and Backcountry Track Systems.

Apache 360 & 360 LT Mounting Kit

(Not illustrated)

G2 2018 & prior (except 6x6 models) G2S 2018 & prior, G2L

715007207

G2 2019 & up (except 6x6 models), G2S 2019 & up

715007206

G2 2018 & prior, G2L (6x6 models)

715004991

G2 (6x6 models 2019 & up)

715005105

- Required to install Apache 360 & 360 LT Track Systems.
- DPS module and pre-filter not included.

Apache Track System Accessories

Air Intake Pre-Filter

715003483



- Adds extra protection to your engine in harsh riding conditions.
- Filter blocks particles larger than 0.007" (0.19 mm).
- Easy, tool-less installation.
- Necessary to maintain vehicle warranty when tracks are installed.
- Required to install the Apache and Backcountry Track Systems.
- Standard on Outlander 650, 650 X mr, 850, 1000, 1000R engines and G2L PRO.
- Not compatible with Snorkel Kits.

Engine Air Intake Pre-Filter

G2, G2L, G2S

715004729



- Adds extra protection to your engine in harsh riding conditions.
- Filter blocks particles larger than 0.005" (0.13 mm).
- Necessary to maintain vehicle warranty when tracks are installed.

APACHE TRACK SYSTEMS FITTING GUIDE

Apache Backcountry

| Model Year / Model | Track | Track Mount | Track DPS Module | Prefilter without Snorkel | Prefilter with Snorkel |
|----------------------|-----------|-------------|------------------|--|------------------------|
| 2015 & Up G2L | 715005247 | 715004830 | 715007338 | 715004729 & 715003483 (standard on G2 models and G2L PRO model) | 715004729 |
| 2018 & Prior G2, G2S | | | | | |
| 2019 & Up G2, G2S | | 715004796 | | | |

Apache 360 and Apache 360 LT

| Model Year / Model | Track | Track Mount | Track DPS Module | Prefilter without Snorkel | Prefilter with Snorkel |
|----------------------|---|-------------|------------------|--|------------------------|
| 2015 & Up G2L | 715006323 (Apache 360) OR 715005103 (Apache 360 LT) | 715007207 | 715007338 | 715004729 & 715003483 (standard on G2 models and G2L PRO model) | 715004729 |
| 2018 & Prior G2, G2S | | | | | |
| 2019 & Up G2, G2S | | 715007206 | | | |

Apache 360 LT 6x6

| Model Year / Model | Track | Track Mount | Track DPS Module | Prefilter without Snorkel | Prefilter with Snorkel |
|---------------------|-----------|-------------|------------------|--|------------------------|
| 2018 & Prior G2 6x6 | 715005104 | 715004991 | 715007338 | 715004729 & 715003483 (standard on G2 models and G2L PRO model) | 715004729 |
| 2019 & Up G2L 6x6 | | | | | |
| 2019 & Up G2 6x6 | | 715005105 | | | |

PROMOUNT PLOWS

PROMOUNT PLOW KITS

Reference Chart

| | 54" Black Steel | 54" Yellow Steel | 60" Black Steel | 60" Yellow Steel | 66" Black Steel | 66" Yellow Steel | 60" Flex2 | 66" Flex2 |
|----------------|-----------------|------------------|-----------------|------------------|-----------------|------------------|-----------|-----------|
| Plow Kit | 715007753 | 715008178 | 715007754 | 715008179 | 715007755 | 715008180 | 715008181 | 715008182 |
| Blade | 715004472 | 715005316 | 715004202 | 715005317 | 715006337 | 715006338 | 715004203 | 715006265 |
| Push Frame | 715007752 | 715007752 | 715007752 | 715007752 | 715007752 | 715007752 | 715007752 | 715007752 |
| Mounting Plate | 715007751 | 715007751 | 715007751 | 715007751 | 715007751 | 715007751 | 715007751 | 715007751 |

Steel Plows

Can-Am ProMount Steel Plow Kits 54" (137 cm) Blade

G2, G2L, G2S

■ 715007753 · Black
■ 715008178 · Yellow



- These kits include:
 - Can-Am ProMount Steel Blade
 - Push Frame with Quick-Attach System
 - Mounting Plate

Can-Am ProMount Steel Plow Kits 60" (152 cm) Blade

G2, G2L, G2S

■ 715007754 · Black
■ 715008179 · Yellow



- These kits include:
 - Can-Am ProMount Steel Blade
 - Push Frame with Quick-Attach System
 - Mounting Plate

Can-Am ProMount Steel Plow Kits 66" (168 cm) Blade

G2, G2L, G2S

■ 715007755 · Black
■ 715008180 · Yellow



- These kits include:
 - Can-Am ProMount Steel Blade
 - Push Frame with Quick-Attach System
 - Mounting Plate

Can-Am ProMount Steel Blades 54" (137 cm) Blade

Fits ProMount Push Frame

■ 715004472 · Black
■ 715005316 · Yellow



- Blades available individually to create your own kit.
- Compatible with Can-Am ProMount Blade accessories to further enhance plow versatility (some plow accessories are not compatible with 54" (137 cm) plows).
- Not compatible with ProMount Drift Cutters, Blade Extensions and Edge Markers.
- Clears 50" (127 cm) when plow is fully angled.
- Blade height of 14.75" (37 cm).

**Can-Am ProMount Steel Blades
60" (152 cm) Blade**

Fits ProMount Push Frame

■ **715004202** · Black
■ **715005317** · Yellow



- Blades available individually to create your own kit.
- Compatible with Can-Am ProMount Blade accessories to further enhance plow versatility.
- Clears 54" (137 cm) when plow is fully angled.
- Blade height of 17" (43 cm).

**Can-Am ProMount Steel Blades
66" (168 cm) Blade**

Fits ProMount Push Frame

■ **715006337** · Black
■ **715006338** · Yellow



- Blades available individually to create your own kit.
- Compatible with Can-Am ProMount Blade accessories to further enhance plow versatility.
- Clears 60" (152 cm) when plow is fully angled.
- Blade height of 17" (43 cm).

**Can-Am ProMount Steel Blades
72" (183 cm) Blade**

Fits ProMount Push Frame

■ **715004474** · Black
■ **715006021** · Yellow



- Blades available individually to create your own kit.
- Compatible with Can-Am ProMount Blade accessories to further enhance plow versatility.
- Clears 66" (168 cm) when plow is fully angled.
- Blade height of 17" (43 cm).

Can-Am ProMount Flex2 Plow Kit

Can-Am ProMount Flex2 – 60" (152 cm) Plow Kit

G2, G2L, G2S

715008181



- These kits include:
 - Can-Am ProMount Flex2 Blade
 - Push Frame with Quick-Attach System
 - Mounting Plate

NEW Can-Am ProMount Flex2 – 66" (168 cm) Plow Kit

G2, G2L, G2S

■ **715008182** · Black



- This kit includes:
 - Can-Am ProMount Flex2 blade
 - Push Frame with Quick-Attach System
 - Mounting plate

Angle Plows

| | | |
|---|--------------|------------------|
| Can-Am ProMount Angle Blades 60" (152 cm) Steel Oneway State Blade | G2, G2L, G2S | 715007261 |
|---|--------------|------------------|



- Make the job easier with the right tools, clear long alleys and make the task easier by sending the snow further out of the way.
- Wing end of plow measures 25" (63 cm) high and tapers down to 17" (43 cm).
- One-way "winged" state plow designed to throw snow higher.
- Rubber flap (715007299) designed to keep snow away from the driver is offered as accessory (sold separately).
- Can-Am branded.

| | | |
|---|--------------|------------------|
| Can-Am ProMount Angle Blades 66" (168 cm) Steel Oneway State Blade | G2, G2L, G2S | 715007263 |
|---|--------------|------------------|



- Make the job easier with the right tools, clear long alleys and make the task easier by sending the snow further out of the way.
- Wing end of plow measures 25" (63 cm) high and tapers down to 17" (43 cm).
- One-way "winged" state plow designed to throw snow higher.
- Rubber flap (715007299) designed to keep snow away from the driver is offered as accessory (sold separately).
- Can-Am branded.

| | | |
|---|--------------|------------------|
| Can-Am ProMount Angle Blades 72" (183 cm) Steel Oneway State Blade | G2, G2L, G2S | 715007264 |
|---|--------------|------------------|



- Make the job easier with the right tools, clear long alleys and make the task easier by sending the snow further out of the way.
- Wing end of plow measures 25" (63 cm) high and tapers down to 17" (43 cm).
- One-way "winged" state plow designed to throw snow higher.
- Rubber flap (715007299) designed to keep snow away from the driver is offered as accessory (sold separately).
- Can-Am branded.

| | | |
|---|--|------------------|
| ProMount One-Way State Blade Rubber Flap <i>(Not illustrated)</i> | | 715007299 |
|---|--|------------------|

- Allows for more efficient snow projections in various snow conditions.

Can-Am ProMount Flex2 Plows

| | | |
|--|--------------------------|------------------|
| Can-Am ProMount Flex2 Blades – 60" (152 cm) Blade | Fits ProMount Push Frame | 715004203 |
|--|--------------------------|------------------|



- Plow blade made of UHMWPE, flexible and impact absorbing material prevents damaging your plow when accidental impacts occur.
- Replaceable wear blade.
- Large pin designed for easy blade rotation to eliminate snow buildup at pivot point.
- Blade design provides best snow roll-off at any angle.
- Compatible with Can-Am ProMount Blade accessories to further enhance plow versatility.
- Clears 54" (137 cm) when plow is fully angled.

| | | |
|---|--------------------------|------------------|
| NEW Can-Am ProMount Flex2 66" (168 cm) Blade | Fits ProMount Push Frame | 715006265 |
|---|--------------------------|------------------|



- Plow blade made of UHMWPE, flexible and impact absorbing material prevents damaging your plow when accidental impact occurs.
- Replaceable wear blade.
- Large pin designed for easy blade rotation to eliminate snow buildup at pivot point.
- Blade design provides best snow roll-off at any angle.
- Clears 60" (152 cm) when plow is fully angled.
- Blade height of 17" (43 cm).
- Compatible with Can-Am ProMount Blade accessories to further enhance plow versatility."

| | | |
|--|--------------------------|------------------|
| Can-Am ProMount Flex2 Blades – 72" (183 cm) Blade | Fits ProMount Push Frame | 715004485 |
|--|--------------------------|------------------|



- Plow blade made of UHMWPE, flexible and impact absorbing material prevents damaging your plow when accidental impacts occur.
- Replaceable wear blade.
- Large pin designed for easy blade rotation to eliminate snow buildup at pivot point.
- Blade design provides best snow roll-off at any angle.
- Compatible with Can-Am ProMount Blade accessories to further enhance plow versatility.
- Clears 66" (168 cm) when plow is fully angled.

Can-Am ProMount Plow Accessories

Can-Am ProMount Push Frame with Quick-Attach System

G2, G2L, G2S

715007752



- Heavy-duty steel tubes designed to withstand the roughest use.
- Mid-mount carriage provides ultimate push strength and traction.
- Designed for maximum plow lift height.
- Features a self-aligning quick-attach system, an easy foot release pedal and an ergonomic handle for plow angle adjustment.
- Plow Roller Fairlead and Plow Limit Switch recommended to extend winch cable lifespan.
- Can-Am ProMount Mounting Plate required for installation.
- Blade swivels left or right, 5 positions.
- Large pin designed for easy blade rotation to eliminate dirt and snow buildup at pivot point.

Can-Am ProMount Mounting Plate

G2, G2L, G2S

715007751



- Required to install the Can-Am ProMount Push Frame with Quick-Attach System.
- Mounting plate precision-designed to stay on year round without compromising ground clearance.
- Fits on ATVs with or without Can-Am Skid Plates.
- Plow Roller Fairlead included.

Can-Am ProMount Push Frame Extension

G2, G2L, G2S

715006257



- 12" (30 cm) push frame extension.
- Required when plow is installed with Apache Track System.

Can-Am ProMount Edge Markers

G2, G2L, G2S

715004206



- Help locate the edges of your plow.
- Height: 24" (60 cm).
- Sold in pairs.
- Compatible with Can-Am ProMount Steel and Flex2 Blades with or without Blade Extensions (except for the Can-Am ProMount Steel 54" (137 cm) Blades).

Can-Am ProMount Drift Cutters

G2, G2L, G2S

715006258



- Help keep snow in the plow.
- Dimensions: 17" x 13" (43.2 cm x 33 cm).
- Sold in pairs.
- Compatible with Can-Am ProMount Steel and Flex2 Blades with or without Blade Extensions (except for the Can-Am ProMount Steel 54" (137 cm) Blades).

Can-Am ProMount Curved Wear Blade

G2, G2L, G2S

715007791 • 60" (152 cm)

715007792 • 66" (168 cm)



- Wear blade designed with a folded back bottom lip.
- The increased surface allows for less digging while plowing uneven surfaces.
- Ideal for snow covered gravel, grass, paver stone and other soft surfaces.

Can-Am ProMount Plastic Wear Blade

G2, G2L, G2S

715004480 • 54" (137 cm)

715004481 • 60" (152 cm)

715004482 • 66" (168 cm)

715004483 • 72" (183 cm)



- To help prevent scratches on smooth driveways and markable surfaces.

Can-Am ProMount Blade Extensions

G2, G2L, G2S

■ **715004205** - Black
■ **715005319** - Yellow



- Add 3" (8 cm) each side.
- Compatible with Can-Am ProMount Blades (except for Can-Am ProMount Steel 54" (137 cm) Blade).
- Longer Wear Blade can be installed to further extend the extra length already provided by the extensions.
- Compatible with Can-Am ProMount Steel and Flex2 Blades (except for the Can-Am ProMount Steel 54" (137 cm) Blades).

Back Drag Blade

ProMount Plows (60" and more)

715007794



- ¼ thick steel swivel scraper.
- Lifts up when the vehicle is moving forward so as not to affect the scraping.
- Increased capacity to pull snow.
- More aggressive scraping in reverse mode.
- Lifts the blade off the ground so that it scrapes evenly.
- Adjustable in length for compatibility with 60", 66" and 72" blades.
- Compatible with ProMount blades (Flex and Steel).

Plow Roller Fairlead

G2, G2L, G2S

705009222



- Larger diameter lower roller reduces wear on wire rope for plow application.
- Can be used with all ProMount plows.
- Included in plow mounting plate kit (715007751).

Pulley Kit for Alpine Super-Duty Plow

G2, G2L

715000279



- Pulley kit to be used in conjunction with the winch when using a snow plow.
- Recommended to increase winch efficiency.
- To be used with the XT Front Bumper.

Synthetic Winch Cable for Plowing

715000540



- Specially designed for plowing applications.
- 8' (2.4 m) section of durable, extra-strong synthetic rope.
- Stands up to repeated, sharp angle pulls used to lift heavy plow blades.
- Temporarily replace your winch rope for plow season to save wear and tear on wire rope.

Plow Limit Switch

(Not illustrated)

G2, G2L, G2S

715006259

- For controlling the cable tension when over raising your plow system.
- Prevents winch, plow push frame and vehicle damage.

Can-Am ProMount Plow Angling System

G2, G2L, G2S

715007801



- Converts your plow system into an easy-to-control unit from the driver's seat.
- Using one hand to control all plow motions will allow you to easily concentrate and manage your plowing tasks.
- Compatible with ProMount Blade.
- Push Frame (715007752) is required.
- Push Frame Extension (715006257) is required for installation with the Front Rancher Bumper.
- Winch and plow sold separately.

TIRES & RIMS

Tires

Carlisle ACT Tire

G2 (500-1000 XT models only)

705401333 · Front
705401334 · (€)

705501769 · Rear
705501770 · (€)



- Front - 26" x 8" x 12".
- Rear - 26" x 10" x 12".

Carlisle ACT Tire

G2 (400 XT models only)

705400606 · Front
705400326 · (€)

705500598 · Rear (€)



- Front - 25" x 8" x 12".
- Rear - 25" x 11" x 12".

Carlisle ACT HD Tire

705402562 · Front

705502940 · Rear



- Front - 26" x 8" x 12".
- Rear - 26" x 10" x 12".

Carlisle Badlands A/R Tire

G2 (500-1000 Base models only)

705401331 · Front
705401332 · (€)

705501767 · Rear
705501768 · (€)



- Front - 26" x 8" x 12".
- Rear - 26" x 10" x 12".

Carlisle Trail Wolf Tire

G2 (400 Base models only)
G2L (450/570)

705402890 · Front
705400607 · (€)

705503225 · Rear
705502165 · (€)



- Front - 25" x 8" x 12".
- Rear - 25" x 11" x 12".

ITP TerraCross Tire







G2 XTP, G2 Limited

705402973 · Front

705502858 · Rear



- This smooth-riding tire will command every bit of traction from the ground while still managing to float across loose snow, sand and mud.
- Features extreme-duty construction for improved puncture protection and extra-tough rubber compound for increased tread life. The interlocking tread pattern and wide footprint make it one of the toughest and grippiest radials around.
- Not EC compliant.
- Front - 26" x 8" x 14".
- Rear - 26" x 10" x 14".

| | | |
|---|--|---|
| ITP Holeshoot ATR Tire | G2S | 705400600 · Front 705400475 · C€ 705500926 · Rear 705500820 · C€ |
|  | <ul style="list-style-type: none"> • Front - 205/80R12 - 25" x 8" x 12". • Rear - 270/60R12 - 25" x 10" x 12". | |
| ITP Mega Mayhem | G2 X mr 570 & 650 2018 & up G2S X mr 570 2018 & up | 705402131 · Front 705502645 · Rear |
|  | <ul style="list-style-type: none"> • 1.5" tread depth mud thrower tires. • Surprisingly smooth ride on hard pack surfaces. • 6-ply rated. • Front - 28" x 9" x 12". • Rear - 28" x 11" x 12". | |
| ITP Cryptid Tire | G2 X mr 850 & 1000R 2018 & up G2S X mr 1000R 2018 & up | 705402671 |
|  | <ul style="list-style-type: none"> • Graduated lug height and paddle-like shoulder configuration provide maximum side bite for climbing in and out of the mud without compromising ride comfort on trails and hard pack. • 6-ply rated. • 30" x 9" x 14". | |
| Gorilla Silverback Tire | G2 (850 & 1000 models only) | 705401501 |
|  | <ul style="list-style-type: none"> • AT30X9-14 Gorilla Silverback mud tire. • Sold individually. • Not EC compliant. • 30" x 9" x 14". | |
| Maxxis Mudzilla Tire | G2 (X mr 570 & 650 models only) | 705501836 · Rear |
|  | <ul style="list-style-type: none"> • Not EC compliant. • Rear - 28" x 10" x 12". | |
| Kenda Klaw MXR Tire | DS 90 X | V42711DGF01HLL · Front V42712DGF01HLL · Rear |
|  | <ul style="list-style-type: none"> • Front - 20" x 6" x 10". • Rear - 18" x 10.5" x 8". | |

Rims

14" Rim



G2 DPS, G2 XT, G2 MAX 650, G2 MAX XT, G2 MAX Limited

705401853 - Front
705401852 - Front
705401851 - Front
705502402 - Rear
705502401 - Rear
705502400 - Rear

■ Black and machined
■ Black with clear coat
■ Silver with clear coat
■ Black and machined
■ Black with clear coat
■ Silver with clear coat

- Premium cast aluminum black painted with machining and clear coat rim.
- Center hole: 72 mm.
- Bolt circle pattern: $\frac{3}{16}$ mm.

- Front - 14" x 6.5" offset = 40 mm.
- Rear - 14" x 8.5" offset = 50 mm.

Note: Matching Nuts - 250100100 Black, 250100082 Chrome/Matching Cap - 705400928

14" Rim



G2 DPS, G2 XT, G2 MAX Limited, G2 North Edition, G2 MAX North Edition

705402309 - Front
705402222 - Front
705402307 - Front
705502770 - Rear
705502702 - Rear
705502768 - Rear

■ Black and machined
■ Black with clear coat
■ Silver with clear coat
■ Black and machined
■ Black with clear coat
■ Silver with clear coat

- Front - 14" x 6.5" offset = 40 mm.
- Rear - 14" x 8.5" offset = 50 mm.

Outlander X mr and Traxter Rim



X mr models front and rear wheels

705401848 - Front
705401849 - Front

■ Black and machined
■ Black

- Cast aluminum rim with trend setting explosive styling so you can ride—and look—like a trailblazer.
- Front - 14" x 6.5" offset = 10 mm.

Note: Matching Nuts - 250100100 Black, 250100082 Chrome/Matching Cap - 705401541

Outlander Rim (Camo Model)



G2, G2L, G2S

705401127 - Front
705501493 - Rear

■ Black with clear coat
■ Black with clear coat

- Black with clear coat aluminum rim.
- Front - 12" x 6" offset = 41 mm.
- Rear - 12" x 7.5" offset = 51 mm.

12" Beadlock Rim



G2, G2L, G2S

705401678 - Front
705502244 - Rear

■ Black
■ Black

- Black with clear coat aluminum rim.
- Needs 16 bolts (250000787) for installing the beadlock.
- Choice of beadlock color (not included).
- Front - 12" x 6" offset = 41 mm.
- Rear - 12" x 7.5" offset = 51 mm.

12" Beadlock Ring



G2, G2L, G2S

705401763 - ■ Can-Am Red
705401810 - ■ Yellow

705401811 - ■ Orange Crush
705401812 - ■ Manta Green

- Cast aluminum beadlock.
- Must be installed on Front Rim (705401678) and Rear Rim (705502244).

Note: Matching Nuts - 250100184 Black, 250100185 Chrome/Matching Cap - 705400928

14" Beadlock Rim

G2

705401594 · Front

■ Black

705503191 · Rear

■ Black



- Black with clear coat aluminum rim.
- Choice of beadlock color (not included).
- Needs 16 bolts (250000787) for installing the beadlock.
- Front - 14" x 6.5" offset = 41 mm.
- Rear - 14" x 8" offset = 51 mm.

14" Beadlock Ring

G2

705401586 · ■ Manta Green

705401837 · ■ Can-Am Red

705401702 · ■ Octane Blue

705401840 · ■ Black



- Cast aluminum beadlock.
- Must be installed on Front Rim (705401594) and Rear Rim (705503191).

Note: Matching Nuts - 250100184 Black, 250100185 Chrome/Matching Cap - 705400928

TRUST GENUINE CAN-AM PARTS

To keep your vehicle performing at its best.

BRP 2-YEAR LIMITED WARRANTY*

Precisely engineered.
Rigorously tested.
Factory approved.

The limited warranty is subject to the exclusions, limitations of liabilities and all other terms and conditions of BRP's standard limited warranty. See the complete limited warranty applicable to your product, or contact your authorized Can-Am Off-Road dealer. Applicable only to BRP products purchased at authorized BRP dealers or distributors. This limited warranty may not apply to factory-installed parts and accessories. Always refer to the product-specific limited warranty. Some states and provinces do not allow for some disclaimers, limitations and exclusions and, as a result, you have other specific rights.

CAN-AM ATVs



To make sure your ATV performs as you expect,
keep an eye on these components:**

OIL FILTER 420256188

ENGINE OIL*

4T 10W-50 Synthetic Oil

1 quart / 946 ml 9779234
1 US gallon / 3.785 L 9779235

4T 0W-40 Synthetic Oil

1 quart / 946 ml 9779139
1 US gallon / 3.785 L 9779140

4T 5W-40 Synthetic Blend Oil

1 quart / 946 ml 9779133
1 US gallon / 3.785 L 9779134

OIL CHANGE KIT**

5W-40 Synthetic Blend Oil

500 cc or more V-twin engine 9779258

0W-40 Synthetic Oil

500 cc or more V-twin engine 9779259

10W-50 Synthetic Oil

500 cc or more V-twin engine 9779252

5W-40 Synthetic Blend Oil

450cc or less 9779256

0W-40 Synthetic Oil

450cc or less 9779257

FUEL FILTER

709001120

AIR FILTER

Performance Air Filter by Twin Air¹

715001333

Premium Air Filter

707800371

CVT AIR FILTER

G2S

707001786

G2, G2L

715003483

DRIVE BELT

450CC & less

Premium (Stock) 422280283

500CC & more

Premium (Stock) 422280360

BRAKE PADS

Metallic G2

Front & Rear Left 715900248

Front & Rear Right 715900249

Organic G2, G2L, G2S

(except X mr models)

Front & Rear Left 715601015

Front & Rear Right 715601014

CV BOOT KITS

G2, G2L, G2S

(except X mr models)

Front Wheel Side 705401345

Front Differential Side 705401346

Rear 705501864

X mr models

Front Wheel Side 705401354

Front Differential Side 705401355

Rear 705501864

WHEEL BEARINGS

293350126

A-ARM BUSHING KIT

703500875

BALL JOINTS

Upper

706202044

Lower

706202045

SPARK PLUG

450, 850, 1000R engines 715900352

570, 650, 1000 engines 715900642

BATTERY

G2S, G2, G2L

18 Amps. Wet (YTX20L-BS) 296000444

DS (250, 90, 70, 50)

13 Amps. Wet

(YTX16L-BS)

V31500MAA020

* For Europe, please check correspondent part numbers on page 56.

**Refer to periodic maintenance chart for proper intervals.

GENUINE PARTS

Oil Filters

| Oil Filters | Models | Oil Filter | Sealing Ring (Oil Filter Cover) | Sealing Ring (Drain Plug) |
|---|------------------------|-------------------|---------------------------------|---------------------------|
|  | Maverick | 4209561 23 | 420230923 | 420552280 |
| | Maverick Trail & Sport | 4202561 88 | 420230923 | 420552280 |
| | G2S, G2 & G2L | 4202561 88 | 420230923 | 420552280 |

Complete Engine Oil Change Kit also available — see page 56

Air Filters

| Premium Air Filter | Models | |
|--|---|--|
|  | | <ul style="list-style-type: none"> • Premium quality filter. • Prevents airborne contaminants from reaching your engine. • Protects internal components against premature wear. |
| | Traxter/Traxter MAX | 715900394 |
| | Maverick | 715900422 |
| | Maverick Trail & Sport (Engines 700 & 1000) | 715900394 |
| | Maverick Trail & Sport (Engine 1000R) | 715900422 |
| G2S, G2 & G2L | 707800371 | |

| Performance Air Filter by Twin Air [†] | Models | |
|---|------------------------|---|
|  | | <ul style="list-style-type: none"> • The best choice for the harshest conditions. • Multiple staged oiled filtering foam for superior dust retaining capacity with high air flow. • Washable and reusable. |
| | Maverick | 715002895 |
| | Maverick Trail & Sport | 715002895 |
| | G2S, G2 & G2L | 715001333 |

| CVT Air Filter <i>(Not illustrated)</i> | Models | |
|--|--------------------------------------|------------------|
| | Traxter/Traxter MAX (except X mr) | 706600419 |
| | Maverick | 706600416 |
| | Maverick Trail & Sport (except X mr) | 706600417 |
| | Maverick Trail & Sport X mr | 706600418 |
| | G2, G2L | 715003483 |
| | G2S | 707001786 |

Spark Plug

| Spark Plug | Models | |
|---|--------------------------------|-----------|
|  | Traxter HD10 | 715900244 |
| | Traxter HD9 | 715900642 |
| | Traxter HD7 | 715900785 |
| | Maverick and Maverick Turbo RR | 415130363 |
| | Maverick Trail & Sport 1000R | 715900244 |
| | Maverick Trail & Sport 1000 | 715900642 |
| | Maverick Trail 700 | 715900785 |
| | ATV 450/850/1000R | 715900352 |
| | ATV 570/650/1000 | 715900642 |

Batteries

Yuasa† Batteries

• Top of the line models from the leading preferred original equipment battery supplier in North America.



| Models | 3 A Wet (YTX4L-BS) | 10 A Wet (YTX12-BS) | 18 A Wet (YTX20L-BS) | 30 A, requires Battery Holder (715004431) |
|------------------------|-----------------------|------------------------|-------------------------|---|
| Traxter/Traxter MAX | — | — | 296000444 | 515176151 Except Base and DPS models. |
| Maverick | — | — | 296000444 | — |
| Maverick Trail & Sport | — | — | 296000444 | — |
| G2S, G2 & G2L | — | — | 296000444 | — |
| DS 50, 70 & 90 | V31500MAA020 | — | — | — |
| Renegade 70,110 | V31500MAA020 | — | — | — |
| DS 250 | — | 715900031 | — | — |

Axles

Premium CV Axle

- Premium quality design ideal for off-roading, heavy-duty and low speed torque usage.
- Includes CVs, shaft and boots with the best suited geometry for your Can-Am vehicle.



| Models | Front Left | Front Right | Rear |
|--------------------------|------------|-------------|--------------------------------|
| Traxter MAX | 705401937 | 705401936 | 705502451 |
| Traxter XT-P | 705402353 | 705402353 | 705502451 |
| Traxter HD10 | 705401937 | 705401936 | 705502451 |
| Traxter HD9 | 705401937 | 705401936 | 705502451 |
| Traxter HD7 | 705401937 | 705401936 | 705502478 (L) 705502479 (R) |
| Maverick Sport (ABS) | 705402443 | 705402443 | 705502756 |
| Maverick Sport Base, DPS | 705402031 | 705402030 | 705502552 |
| Maverick Trail (W/O ABS) | 705402008 | 705402007 | 705502541 |
| Maverick Trail (ABS) | 705402442 | 705402442 | 705502755 |

All ATVs: Please contact your dealer or visit our online store at can-amoffroad.com for suggested fitment.

Performance CV Axle

(Not illustrated)

- High-performance design ideal for off-road use with superior wheel power and acceleration for racing, dunes, trails and desert riding.
- Includes CVs, shaft and boots with the best suited geometry for your Can-Am vehicle.

| Models | Front Left | Front Right | Rear |
|--------------------------|------------|-------------|-----------|
| Traxter X mr | 705402420 | 705402420 | — |
| Maverick Sport X mr/X rc | 705402282 | 705402282 | 705502757 |

Brakes

Metallic Brake Pad Kit

- Built strong to last long – heavy-duty construction stands up to hard braking.
- Designed to handle demanding riding conditions with challenging braking environments such as mud and dunes.
- Created specifically for use with Can-Am vehicles.



| Models | Front Left | Front Right | Rear Left | Rear Right |
|------------------------|------------|-------------|-----------|------------|
| Traxter MAX HD9/HD10 | 715900379 | 715900380 | 715900386 | 715900387 |
| Traxter HD10 | 715900379 | 715900380 | 715900381 | 715900382 |
| Traxter HD9 | 715900379 | 715900380 | 715900381 | 715900382 |
| Traxter HD7 | 715900379 | 715900380 | — | 715900387 |
| Maverick | 715900379 | 715900380 | 715900386 | 715900387 |
| Maverick Trail & Sport | 715900379 | 715900380 | 715900386 | 715900387 |
| G2S, G2 & G2L | 715900248 | 715900249 | 715900248 | 715900249 |

Please contact your dealer or visit our online store at Can-Amoffroad.com for suggested fitment.

Parts

A-Arm Bushing Kit

703500875

- This bushing kit includes 2 bushings, a sleeve and a wear plate, as illustrated.
- All you need to renew your suspension A-Arms.



Ball Joints

- Robust design for off-road usage and sealed for prolonged durability.



Upper

706202044

Upper (Maverick, Trail & Sport)

706203084

Lower

706202045

Wheel Bearings

(Not illustrated)

- Sealed bearings for additional protection from water and dirt.

2020 models and prior

293350118

2021 & up models

293350126

Maverick

293350141

CV Boot Kit

- Comes with clamps and grease.
- Genuine BRP CV Boot Kits ensure absolute compatibility and a perfect fit.



| Models | Front Wheel Side | Front Differential Side | Rear Wheel & Differential Side |
|--|------------------|-------------------------|--------------------------------|
| Traxter | 705401345 | 705401355 | 705501864 |
| Maverick | 705401354 | 705401354 | 715900450 |
| Maverick Sport (ABS, X xc, X mr, X rc) | 705401354 | 705401355 | 705501864 |
| Maverick Sport (w/o ABS), Maverick Trail | 705401345 | 705401355 | 705501864 |
| G2, G2L, G2S (except X mr) | 705401345 | 705401346 | 705501864 |
| X mr | 705401354 | 705401355 | 705501864 |

Belts

BRP Premium Drive Belt

- High-performance design ideal for off-road use.
- BRP-specific calibration adjusted to best suit your Can-Am vehicle.



| Models | Premium Belt | CVT Gasket Cover | Upgrades |
|---------------------------------------|--------------|------------------|-----------|
| Traxter HD10 | 422280652 | 420450400 | — |
| Traxter HD9 | 422280656 | 420450400 | 422280652 |
| Traxter HD7 | 422280225 | — | — |
| Maverick | 422280652 | 420450405 | — |
| Maverick Trail & Maverick Sport 1000 | 422280656 | 420450400 | 422280652 |
| Maverick Trail 700 | 422280225 | — | — |
| G2, G2S 450 CC & less | 422280283 | 420430126 | — |
| G2, G2S 500 CC & more | 422280366 | 420430126 | — |
| G2L Outlander 450 & Outlander MAX 450 | 422280283 | 420630292 | — |

Driven Pulley Adapter Tool

(Not illustrated)

- Spreads the secondary clutch open for easy belt replacement.

Puller/Locking Tool

(Not illustrated)

- Allows you to spread the secondary clutch open for easy belt replacement.

| Models | Driven Pulley Adapter | Puller/Locking Tool |
|---------------------------------------|-----------------------|---------------------|
| Traxter HD10-HD9 | 708200720 | 529000088 |
| Traxter HD7 | — | 529036098 |
| Maverick Trail & Sport | 708200720 | 529000088 |
| Maverick | 708200720 | 529000088 |
| G2, G2S | — | 529036098 |
| G2L Outlander 450 & Outlander MAX 450 | — | 529036098 |

pDrive Pulley Service kits

Ramp Roller Maintenance Set

SSV pDrive (MY22)
SSV pDrive (MY23)

420629231
Coming winter 2023

pDrive Ramp Roller Set



Torque Roller Maintenance Set

SSV pDrive (MY22)
SSV pDrive (MY23)

420629224
Coming winter 2023

pDrive Torque Roller Set



LUBRICANT & OIL CHANGE KIT

Lubricant

XPS 4T 10W-50 Synthetic Oil

9779234 · 1 qt / 946 ml US
9779240 · EU

9779235 · 1 US gal / 3.785 L



- Engineered for heavy-duty and high-performance 4-stroke engines, including turbocharged, supercharged and racing engines.
- Formulated using carefully selected and strenuously tested base stocks and custom additives.
- Offers thick film strength to protect bearings, and a proven high-temp detergency to minimize deposits, prevent shear, provide thermal stability, and combat fuel dilution to ensure maximum performance from your engine.

XPS 4T 0W-40 Synthetic Oil

9779139 · 1 qt / 946 ml US
9779286 · EU

9779140 · 1 US gal / 3.785 L US
9779287 · EU



- Powersport formula with premium anti-wear and anti-corrosion additives.
- The best choice for high-performance snowmobile, ATV and SXS 4-stroke engines used in cold weather.
- Provides superior engine and transmission protection against heat, rust and corrosion.
- Delivers optimal performance in high and low temperatures.

XPS 4T 5W-40 Synthetic Blend Oil

9779133 · 1 qt / 946 ml US
9779290 · EU

9779134 · 1 US gal / 3.785 L US
9779291 · EU



- Off-road formula with premium anti-wear and anti-corrosion additives.
- Designed for high-performance off-road, on-road and PWC 4-stroke engines, including turbo or supercharged powersports engines.
- Provides superior engine and transmission protection against rust and corrosion, even in extreme conditions.

Oil Change Kit

Engine Oil Change Kit

Models



- Ultra-convenient "all-in-one" Engine Oil Change Kit saves time and money.
- Includes XPS Synthetic or Synthetic Blend Oil, oil filter, O-rings and washer.

| | |
|--|--|
| 5W-40 Synthetic Blend Oil / 450cc or less | 9779256 · US 9779408 · EU |
| 0W-40 Synthetic Oil / 450cc or less | 9779257 · US 9779409 · EU |
| 5W-40 Synthetic Blend Oil / 500 cc or more V-twin engine | 9779258 · US 9779405 · EU |
| 0W-40 Synthetic Oil / 500 cc or more V-twin engine | 9779259 · US 9779406 · EU |
| 10W-50 Synthetic Oil / 500 cc or more V-twin engine | 9779252 · US 9779401 · EU |
| 5W-40 Synthetic Blend Oil / 900 ACE | 9779260 · US 9779410 · EU |
| 10W-50 Synthetic Oil / 900 ACE | 9779261 · US 9779411 · EU |

MAINTENANCE PRODUCTS

Synthetic Gear Oil

75W-90

9779158 · 1 qt / 946 ml US

9779212 · EU

75W-140

9779160 · 1 qt / 946 ml US

9779215 · EU



- Uses custom additives to provide the best performance in Visco-Lok™ and Smart-Lok™ differentials.
- Allows higher loads, superior shear stability and reduced oxidation.
- Exceptional wear protection and superior performance at all operating temperatures.

Extended Life Pre-Mixed Coolant

9779150 · 1 qt / 946 ml

619590204 (Scandinavia)



- Antifreeze/coolant contains the correct dilution and the necessary additives to prevent corrosion and inhibit cavitation in BRP cooling systems.
- Long-life, 5-year formula specially formulated for BRP vehicles.
- Superior heat transfer.
- Ideal replacement for vehicles that normally use a 2-year antifreeze/coolant (green).
- 5 years (orange).

Anti-Corrosive Lubricant

9779167 · 12 oz / 340 g

619590722 (Scandinavia)



- Multipurpose lubricant that can also be used to prevent rust, corrosion and moisture intrusion.
- It contains extreme pressure additives that work as an all-around lubricant for just about anywhere lubrication is needed.

DOT 4 Brake Fluid

9779151 · 12 fl oz / 355 ml US

9779207 · EU



- Meets or exceeds all DOT3 and DOT4 brake fluid requirements.
- High-temperature formula resists fade and also conditions seals and O-rings in braking system.

CARE PRODUCTS

Cleaner and Degreaser, All Purpose

9779328 · 22 fl oz / 650 ml

9779329 · 2 qt / 1.89 L



- Ready-to-use formula.
- Cleans toughest dirt and grime.
- Phosphate free eco-friendly formula.
- Low-foam easy rinse formula.

Matte Finish Waterless Cleaner

9779330 · 22 fl oz / 650 ml



- Easy waterless use.
- Perfect for matte, flat and denim surfaces.
- Contains no wax or silicone.
- Leaves no unwanted streaks or marks.

Multi-Surface and Glass Cleaner

9779331 · 22 fl oz / 650 ml



- Easy waterless spray and wipe use.
- Polymer formula cleans and protects.
- Contains no wax or silicone.
- Leaves no unwanted streaks or marks.

Mud and Dust Off-Road Wash

9779340 · 33 fl oz / 946 ml

9779341 · 2 qt / 1.89 L



- Specially formulated for off-road vehicles, it breaks the bond holding grime and dirt to your vehicle's finish.
- The formula is biodegradable, eco-friendly with no phosphates or corrosive chemicals and is low foam for easy, quick rinsing.
- Effective on oil, grease and other stubborn grime.
- Safe for use on all surfaces.

Black Plastic and Rubber Restorer

9779335 · 7.6 fl oz / 225 ml



- Restores plastic, rubber and vinyl.
- Long-lasting formula.
- Protects against UV rays.

Foaming Wash

9779337 · 16 fl oz / 473 ml

9779338 · 2 qt / 1.89 L



- Concentrated formula for off-road vehicles, it produces a thick foam to lift dirt and prevent scratching.
- The pH neutral formula is safe for wax and paint sealants.
- Works in pressure washers or by hand.

Quick Detailer Gloss Enhancing

9779332 · 4 fl oz / 118 ml

9779333 · 16 fl oz / 473 ml



- Quick detail spray wax.
- Leaves a high gloss finish at every wipe.
- Nanotechnology polymer formula.
- Repels dirt.
- No water needed.

EXPLORE AN ENTIRE WORLD OF ADVENTURE WITH ALL OF OUR BRP PRODUCTS. BRP.COM



ski-doo ***LYNX*** ***SEA-DOO*** ***CAN-AM*** ***ROTAX*** ***ALUMACRAFT*** ***Manitou*** ***QUINTREX***



CAN-AMOFFROAD.COM

A BRP BRAND

